

# Wetland Ecosystem Services Protocol WESP-BC

## Field Assessment Guide Non-Tidal Wetlands

Developed March 2022 through the B.C. Wildlife Federation's Wetlands Workforce project.  
A project supported by the Healthy Watersheds Initiative. Updated June 2026

Created by Kyla Rushton and Neil Fletcher of BCWF, in collaboration with  
Dr. Paul Adamus of Oregon State University  
Illustrations by Charisma Thomas and Chenoa OneDove  
Design by Cheyenne Berghenegouwen, Jamie Long, & Nadia Pagliaro

This project was undertaken with the financial support of:  
Ce projet a été réalisé avec l'appui financier de :



Environment and  
Climate Change Canada

Environnement et  
Changement climatique Canada

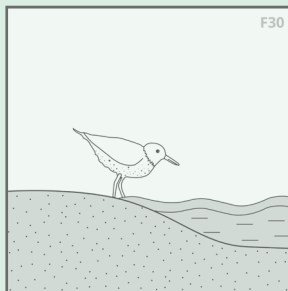
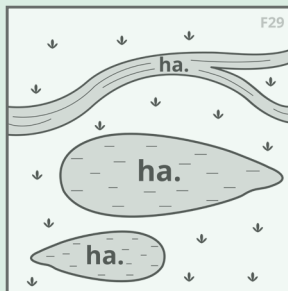
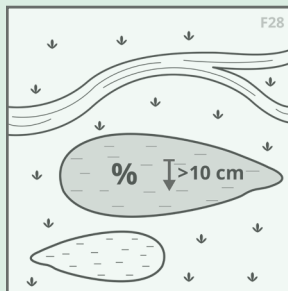
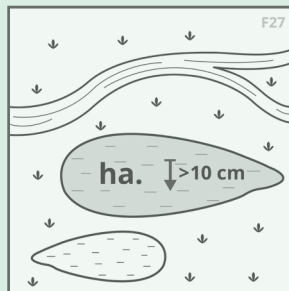
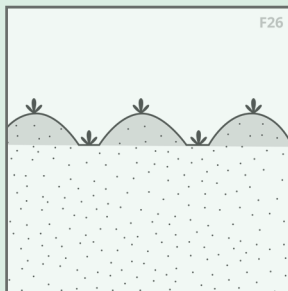

**Stream Flow  
Temperature Support [SFTS]**



A wetland's effectiveness for maintaining normal surface flow and temperature regimes in receiving waters.

**Fire Resistance [FR]**



A wetland's capacity to resist ignition by wildfire, thus potentially limiting wildfire spread. (An attribute, not a function).

**Wetland Sensitivity [Sens]**



A wetland's lack of intrinsic resistance and resilience to human and natural stressors (higher score = more sensitive).

**Organic Matter Export [OE]**



The effectiveness for producing and subsequently exporting organic matter, either particulate or dissolved to downslope receiving waters.

**Water Storage & Delay [WS]**

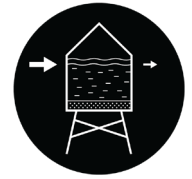

A wetland's effectiveness for storing runoff or delaying the downslope movement of surface water for long or short periods.

**Cultural or Recreational  
Importance [CR]**



Prior designation of the wetland, by a natural resource or environmental protection agency, as some type of special protected area. Also, the potential and actual use of a wetland for low-intensity outdoor recreation, education, or research.

**Native Plant Diversity [PD]**



A wetland's capacity to support a diversity of native, hydrophytic, vascular plant species, communities, and/or functional groups, at either the site scale or through contribution to regional-scale native plant diversity.

**Nitrate Removal  
& Retention [NR]**



A wetland's effectiveness for retaining particulate nitrate and converting soluble nitrate and ammonium to nitrogen gas, primarily through the microbial process of denitrification, while generating little or no nitrous oxide (a potent "greenhouse gas").

**Carbon Presevation [CP]**



The total biomass of organic carbon that has accumulated over time within a wetland's soil/sediment and may be vulnerable to conversion to gaseous form under long-term warming and/or drying conditions. (An attribute, not a function).

**Aquatic Primary  
Productivity [APP]**



A wetland's effectiveness, on a net annual basis, for supporting high production of benthic, epiphytic, and/or planktonic algae and other plants that are critical to the functioning of higher trophic levels.

**Sediment Retention  
& Stabilization [SR]**



A wetland's effectiveness for intercepting and filtering suspended inorganic sediments, thus allowing their deposition, as well as reducing energy of waves and currents, resisting excessive erosion, and stabilizing underlying sediments or soil.

**Phosphorus Retention [PR]**



A wetland's effectiveness for retaining phosphorus for long periods (>1 growing season) as a result of chemical adsorption, or from translocation by plants to belowground zones with less potential for physically or chemically remobilizing phosphorus into the water column.

**Keystone Mammal  
Habitat [KMH]**



A wetland's capacity to support an abundance of wetland-associated mammals that are ecological keystones and/or are of recognized importance as game or for subsistence in this region. Primarily: beaver, muskrat, moose, caribou, bear.

**Waterbird Habitat [WB]**



A wetland's capacity to support or contribute to an abundance or diversity of waterbirds (ducks, geese, grebes, swans, bitterns, rails, shorebirds, others) that breed in or migrate through the region.

**Raptor Wetland Songbird  
Habitat [RSB]**



A wetland's capacity to support an abundance and diversity of native raptor and songbird species and functional groups, especially those that are most dependent on wetlands or water during migration or breeding. Examples include marsh wren, northern harrier, common yellowthroat.

**Amphibian Habitat [AM]**



A wetland's capacity to support an abundance and diversity of native amphibians (frogs, toads, salamanders) and turtles.

**Pollinator Habitat [POL]**



A wetland's capacity to support an abundance and/or diversity of pollinating insects, such as bees, wasps, butterflies, moths, flies, and beetles.

**Fish Habitat [FH]**



A wetland's capacity to support an abundance and diversity of native fish (both resident and anadromous species, stocked and unstocked).

# WESP-BC Assessment Cover Page:

Surveyor(s):

Contact Information:

---

---

---

---

Report date (yy/mm/dd): \_\_\_\_\_

Wetland ID (e.g. SI\_WS26W01): \_\_\_\_\_

Project name/site name: \_\_\_\_\_

Nearest settlement/city: \_\_\_\_\_

EcoProvince: \_\_\_\_\_

BGC zone/subzone: \_\_\_\_\_

Latitude (decimal degrees) (N):

Longitude (decimal degrees) (W):

If delineated, WSA file number (if known):

What percentage (approx.) of the wetland were you able to visit?

---

---

Version of **wespr** R package used: \_\_\_\_\_

Version of field **Survey123** form used (if known): \_\_\_\_\_

If the wetland has been previously mapped, what is the source of the mapping (e.g., FWA, CRIA, TEM, SEI, CNWI, etc.)?

If the wetland has been previously mapped, what is the unique identifier associated with that wetland?

---

---

**Predominant Hydrogeomorphic (HGM) Class<sup>1</sup>:**

Lacustrine = L; Fluvial = F; Palustrine = P; Basin and Hol- lows (Pb); Ponds and Potholes (Pp); Seepage Slopes (Ps)

**Canadian Wetland Classification System (CWCS) Class:**

Bog = B; Fen = F; Swamp = S (indicate if treed = t or shrub- by = s)<sup>2</sup>; Marsh = M; Shallow open water = W

Indicate all present, based on field visit and/or aerial imagery and relative proportion by percent

---

---

Approximate size of the Assessment Area (AA) in hectares:

AA as a percent of the entire wetland (approx.):

**Include a sketch map of wetland assessment area:**

Attach an extra page if desired.

---

Comments about the site or this WESP-BC assessment:

Attach an extra page if desired.

---

---

Have you attended a WESP-BC training session?

If so, indicate approximate month & year

---

How many wetlands have you assessed previously using WESP-BC (approximate)?

---

<sup>1</sup>For more information refer to Wetlands of British Columbia: A Guide to Identification (LMH52), page 41

<sup>2</sup>In this context treed = >25% of the surface area covered by trees? Trees are woody vegetation >5 meters in height and shrubby = >25% of the surface area covered by shrubs? Shrubs are woody vegetation <5 meters in height and exclusive of dwarf vegetation (e.g., *Vaccinium microcarpum*)

AA = Assessment Area; CWCS = Canadian Wetland Classification System; FWA = Fresh Water Atlas; ID = identification; VRI – Vegetation Resource Inventory; WESP-BC = Wetland Ecosystem Services Protocol for British Columbia; WSA – Water Sustainability Act

## Prior to Starting the WESP-BC Field Assessment:

Ahead of completing this field assessment you should read the User Manual for WESP-BC, and follow the directions described in order to roughly delineate Assessment Area (AA) and Contributing Area (CA) prior to beginning the field assessment.

It is imperative to clearly decide on the Assessment Area (AA) prior to beginning any part of the field assessment, because differences in AA will have large impacts on the choices to each question. The AA should be mapped on satellite imagery and available while completing the field assessment.

It is also imperative to determine which ecoprovince and which biogeoclimatic zone (subzone) your wetland occurs in before visiting the field. Wetlands in the drier zones common to the Southern Interior and Central Interior at lower elevations (PP, BG, IDFxh, IDFxw, or DFX) should include an additional 10 m buffer to the wetland as part of the AA to compensate for drought and changes in seasonal water levels.

Mapping out polygons of different vegetation types and open water or streams is optional but recommended to ease the process of completing the assessment and estimating percent covers of different parts of the site.

If possible, the user should also be familiar with the Desktop Assessment prior to visiting the site, in case any questions are difficult to determine from imagery alone and require on-site investigation.

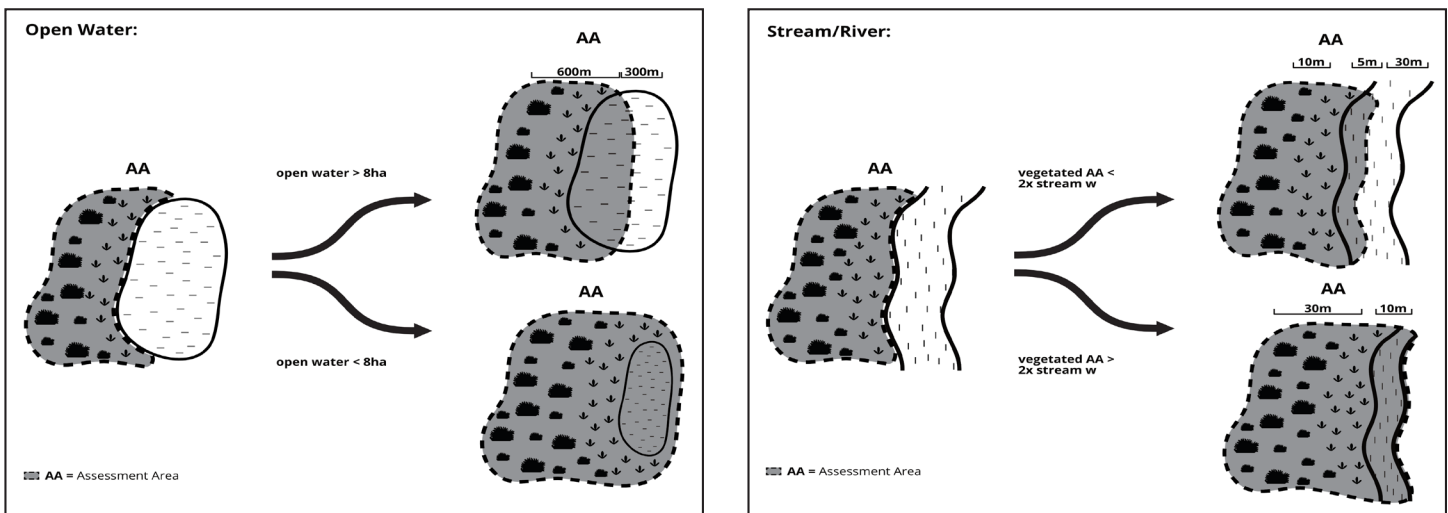

Assessment Areas are not always equal to the entire delineated area as they may be limited to potential impact area, or when adjacent to open water may extend partially or entirely into the open water. Although the User Manual for WESP-BC should be considered for official guidance, some examples of open water treatment include extending partially into lakes over 8 hectares, or into large rivers.

# Variations in Assessment Areas Considered:

In some questions within the field form, the area under consideration may differ, and it's very important to consider the appropriate area when answering each question. For example, some questions specify that they are in relation to only the vegetated area (AAv), in these questions other non-vegetated areas (such as open water or bare saturated substrate) would be ignored. In many of the questions about tree and shrub composition only the woody vegetation in the AA should be considered, and any other areas without woody vegetation would be ignored.

To support the field assessment, it is helpful to map some of the features within the AA such as vegetated areas, areas with trees and shrubs, open water, and notable features that influence the answers of the field assessment.

**AAh:** evaluate the condition with regard to the part of the AA containing surface water [h= hydrology]

**AAah:** evaluate the condition with regard to the AA's surface water plus surface water that abuts the AA [ah=abutting hydrology (surface water)]

**AAv:** evaluate the condition only with regard to the vegetated (v) part of the AA

**AAvE:** evaluate the condition only with regard to the erect vegetation [vE] (herbaceous or woody) in the AA.

**AAvW:** evaluate the condition only with regard to the woody vegetation [vW] in the AA

**AA+U:** evaluate the condition with regard to both the AA and abutting upland (U) (10 m)

**U:** evaluate the condition in parts of the upland described

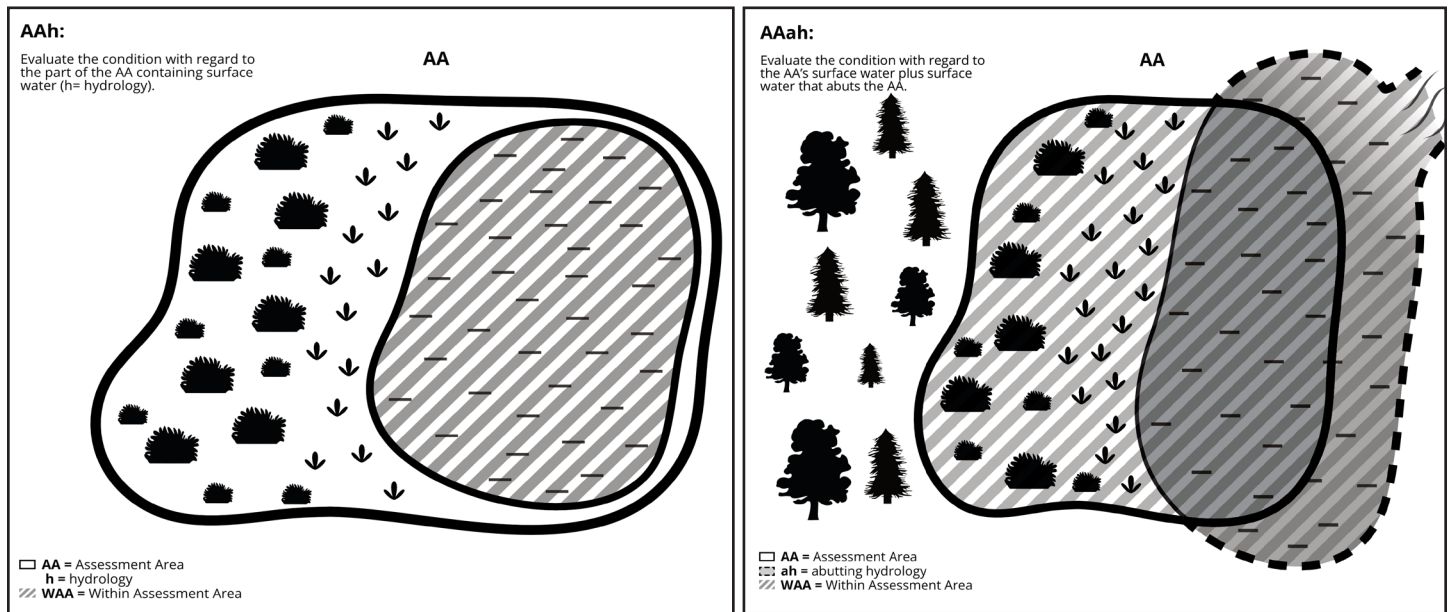

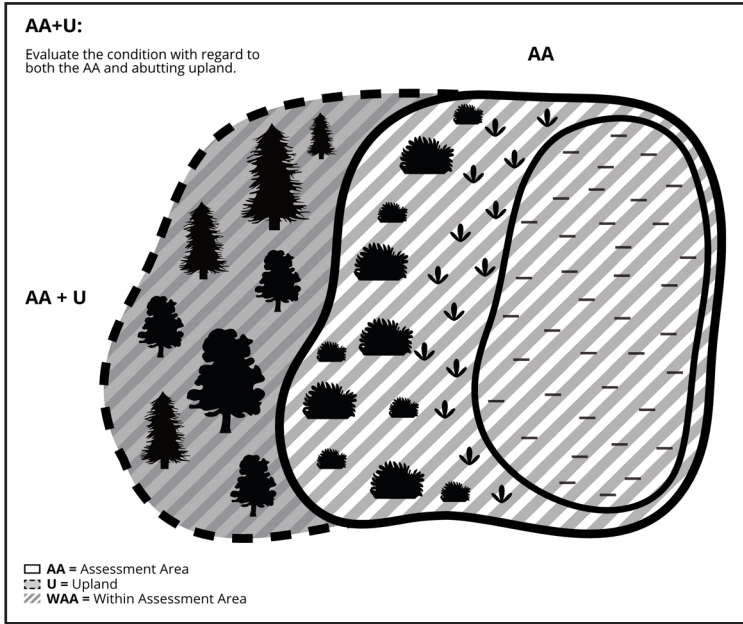
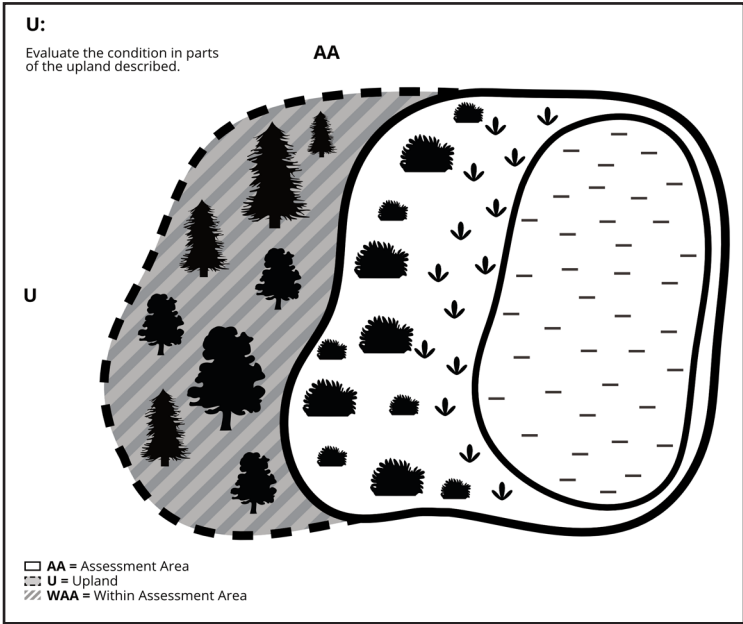
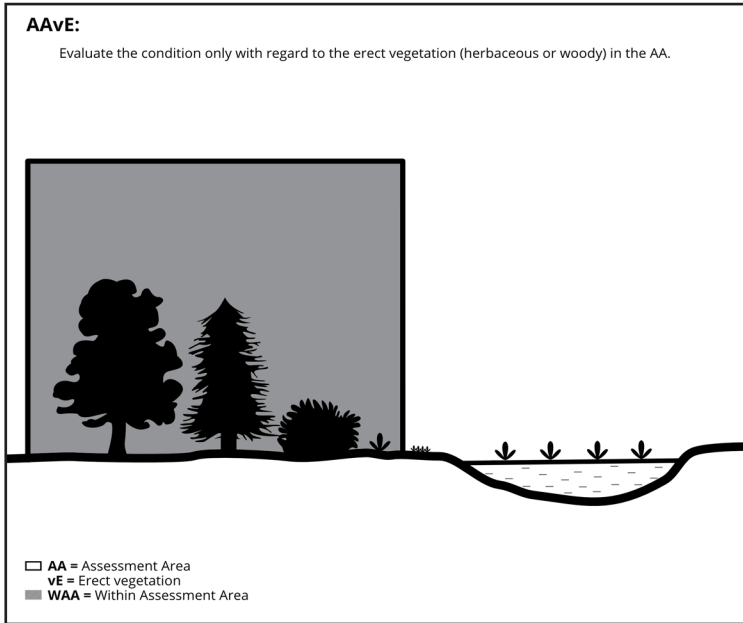
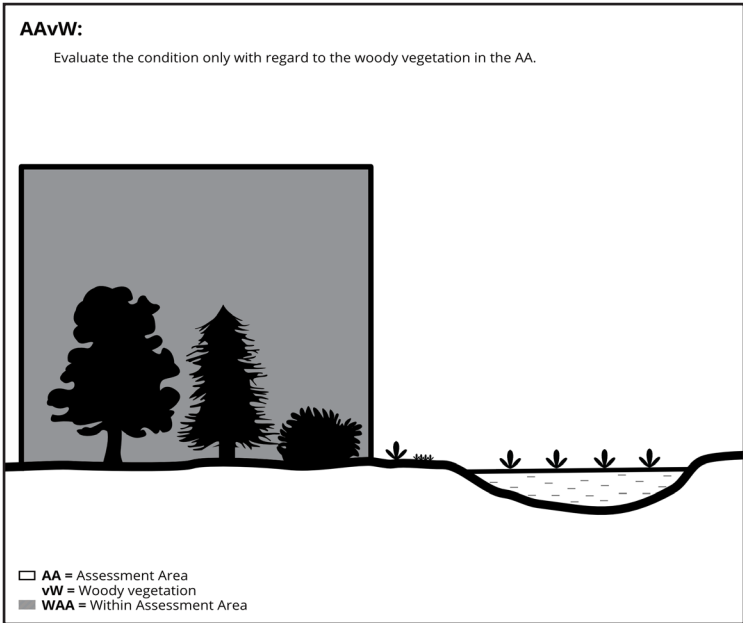
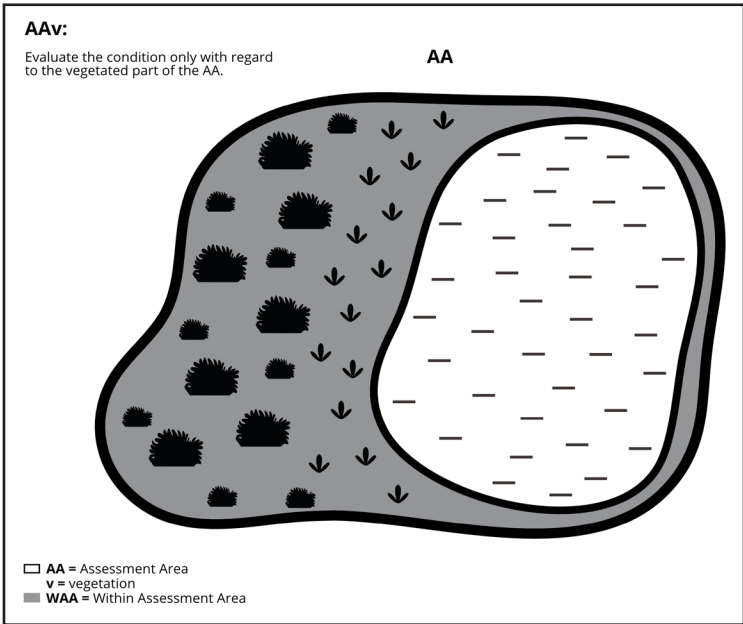

## Field Assessment:

After reviewing available imagery and spatial datasets to identify a preliminary Assessment Area (AA), the first priority during the on-site visit is to confirm the boundaries of the AA and identify feasible travel routes that allow for safe and authorized access to key wetland features.

Where possible, deploy a drone to capture aerial overview images to inform the assessment.

The selected route should enable a comprehensive assessment of the wetland, including mapping of vegetated areas, wooded zones, open water bodies, and varying flood levels. This will facilitate the completion of the WESP Field Assessment Survey and ensure that key wetland characteristics are adequately documented.

- When planning your route, consider the following aspects:
  - The largest herbaceous areas including emergent plants, aquatic vegetation and mosses.
  - Woody areas, such as trees and shrubs.
  - Any surface water
  - Wetland inlet and outlets.

\*If maps and aerial imagery suggest that the wetland lacks an outlet, verify this by walking no more than 1 km toward the lowest elevation of the wetland. Look carefully for an outlet, which may include seasonal flows or subterranean drainage through pipes.

Throughout the site, make detailed observations and record them in field notes or on a standardized form, such as the Canadian National Wetland Inventory plots, FS1333 (Site Visit) or Wetland Determination forms, depending on the scope of your assessment. Your notes should include information on soil texture, plant composition (including any invasive species), and dominant plant species. Where possible, roughly map the plant associations observed across the site.

Complete the WESP Field Assessment Survey form and enter it into the the Survey123 form. The answer sheets at the end of this booklet can be used to fill out the survey123 afterwards. When answering questions, base your responses primarily on on-site observations and interpretations. While doing so, consult additional resources such as aerial imagery, topographic maps, spatial data layers, and local knowledge from the landowner or other experts in the area. For

## Items to Take into the Field:

### Field Backpacks:

- |   |   |  |
|---|---|--|
| <ul style="list-style-type: none"><li>• Local plant ID books</li><li>• LMH 52 guide</li><li>• PH + EC meter (+ batteries)</li><li>• Soil Auger</li><li>• Tape Measure</li></ul> | <ul style="list-style-type: none"><li>• Bug spray/net</li><li>• Sun hat/sunglasses</li><li>• Water</li><li>• Lunch/snack</li><li>• First Aid kit</li><li>• Sunscreen</li><li>• Bear Spray</li></ul> | <p>Optional:</p> <ul style="list-style-type: none"><li>• Tablet for digital field collection</li><li>• Drone (with batteries and SD card)</li><li>• Specific vegetation and soils plot forms</li><li>• Clipboard for paper forms</li></ul> |
|---|---|--|

### Digital Resources:

- Offline WESP Field Assessment Survey123 form (if using digital version)
- Offline map with satellite imagery for the AA and at least a 300m surrounding area
  - \* Freshwater Atlas – Streams
  - \* BC ParcelMap or land ownership information for the site (if uncertain about ownership boundaries)
  - \* Species and ecosystems at risk occurrences or habitat (optional)
  - \* Other relevant site data such as Terrestrial Ecosystem Mapping (if available)

## Visual Estimate of Foliage Cover:

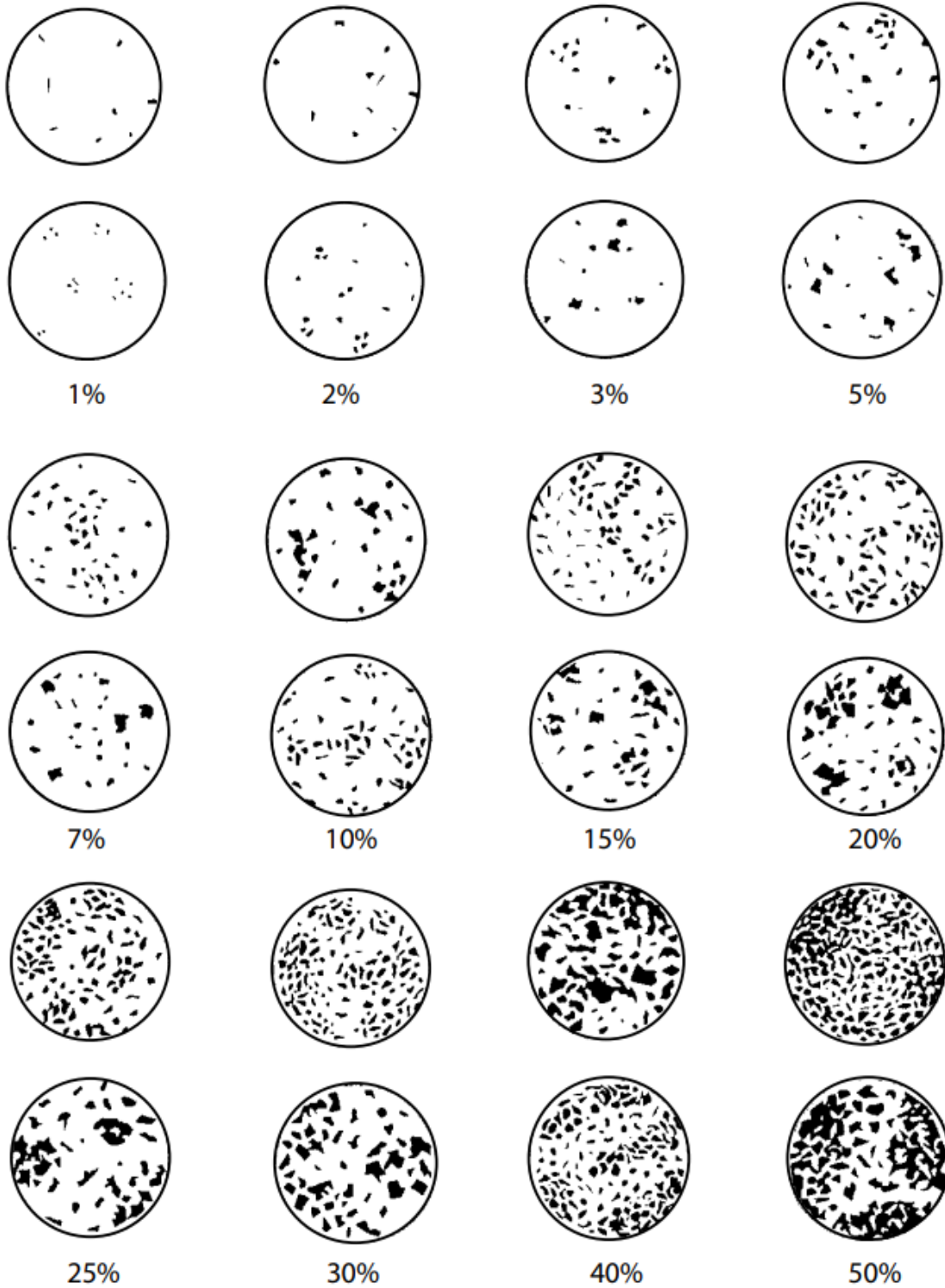

Source: Field Manual for Describing Terrestrial Ecosystems 2nd Edition.  
[https://www.for.gov.bc.ca/hfd/pubs/docs/lmh/lmh25/Lmh25\\_2015.pdf](https://www.for.gov.bc.ca/hfd/pubs/docs/lmh/lmh25/Lmh25_2015.pdf)

# F Form

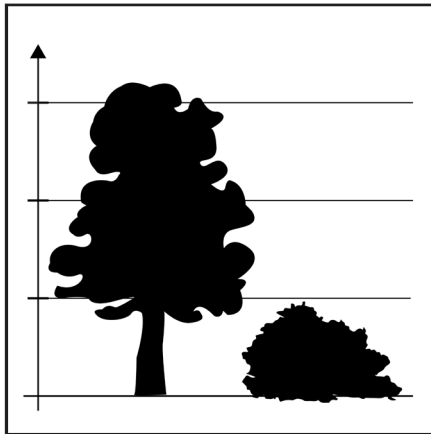

## F1 [AAv]: Vegetation Height and Form Diversity



Following EACH row below, indicate with a number code the percentage of the vegetated part of the AA (excluding submerged and floating-leaved aquatics) which is occupied by that type of woody cover. Woody cover should include woody plants beneath a canopy of taller vegetation. Percentages may sum to less than 100% (if vegetation is largely herbaceous or moss) or more than 100% (if multiple vertical strata of woody plants are present). If no woody vegetation is present, leave this question blank.

**Coniferous (including Tamarack) taller than 3 metres.**

(A) > 95%	(B) 76 - 95%	(C) 51 - 75%	
(D) 26 - 50%	(E) 11 - 25%	(F) 1 - 10%	(G) <1%

**Deciduous (including alder, willow, birch and blueberry) taller than 3 metres.**

(A) > 95%	(B) 76 - 95%	(C) 50 - 75%	
(D) 26 - 50%	(E) 11 - 25%	(F) 1 - 10%	(G) <1%

**Coniferous or Evergreen 1 - 3 metres tall (e.g., Stunted Black Spruce).**

(A) > 95%	(B) 76 - 95%	(C) 51 - 75%	
(D) 26 - 50%	(E) 11 - 25%	(F) 1 - 10%	(G) <1%

**Deciduous 1 - 3 metres tall.**

(A) > 95%	(B) 76 - 95%	(C) 51 - 75%	
(D) 26 - 50%	(E) 11 - 25%	(F) 1 - 10%	(G) <1%

**Coniferous or Evergreen < 1 metres tall (e.g., many Ericaceous Shrub species).**

(A) > 95%	(B) 76 - 95%	(C) 51 - 75%	
(D) 26 - 50%	(E) 11 - 25%	(F) 1 - 10%	(G) <1%

**Deciduous < 1 metres tall (e.g., Deciduous tree seedlings).**

(A) > 95%	(B) 76 - 95%	(C) 51 - 75%	
(D) 26 - 50%	(E) 11 - 25%	(F) 1 - 10%	(G) <1%

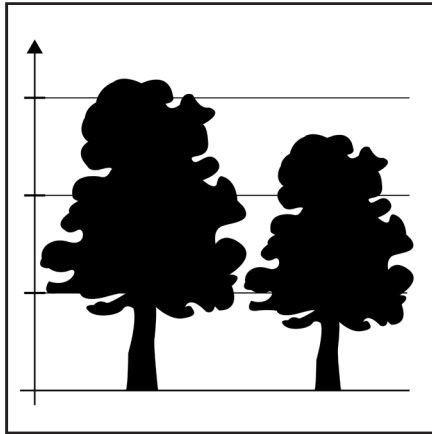

## F2 [AAv & Aerial]: Height Class Interspersion



If <1% of the vegetated AA contains woody vegetation taller than 3 m, leave this question blank and **SKIP to F4**. Otherwise, follow the key below and mark **ONE** option that best describes **MOST** of the vegetated part of the AA.

**A.** Step 1: Does your site have >1% of woody vegetation (>3 m)?

If yes, proceed to Step 2. If <1% of the vegetated assessment area (AAv) contains woody vegetation >3 m tall, select "NA".

**B.** Step 2: Determine the dominant height class (from an aerial perspective).

**C.** Consider the vegetated portion of your AA (AAv). It may be helpful to sketch the AAv or look at aerial imagery and circle areas of tall vs. short vegetation.

Divide vegetation into two height classes:

- i. Tall vegetation: >3 m (woody only)
- ii. Short vegetation: <3 m (woody or herbaceous\*)

\*Do not include mosses or aquatic plants. "Canopy" refers to foliage visible from above. Do not include short vegetation hidden under taller canopy.

**D.** Is your site dominated (>60% of AAv) by one height class?

- i. Yes (over 60% of my AAv is either >3 m or <3 m)
  1. The two height classes are scattered or mostly interspersed = A1
  2. The two height classes mostly in separate clumps, or only one height class is present = A2
- ii. No – my AAv is approximately covered half by vegetation >3 m, and covered half by vegetation <3 m
  1. The two height classes are scattered or mostly interspersed = B1
  2. The two height classes mostly in separate clumps, or only one height class is present = B2

**More Details:** Tall means >3 m. Short vegetation can be woody or herbaceous and should not include moss or aquatic plants. "Canopy" refers to foliage visible from an aerial perspective. For this question, do not include short vegetation directly beneath the canopy. "Erect vegetation" includes all woody species plus herbaceous species that remain sufficiently upright to support bird nests throughout the entire growing season, e.g., cattail, bulrush, some sedges and rushes.

**A** **A1.** The two height classes are scattered or mostly interspersed..

**B** **A2.** The two height classes mostly in separate clumps, or only one height class is present.

**C** **B1.** The two height classes are scattered or mostly interspersed.

**D** **B2.** The two height classes mostly in separate clumps, or only one height class is present.

**E** N/A (<1% woody cover)

### F2 Visual Aid |

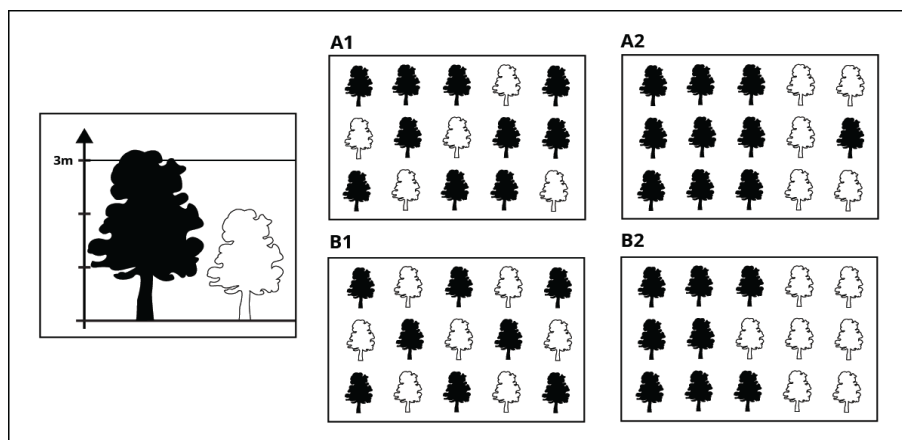

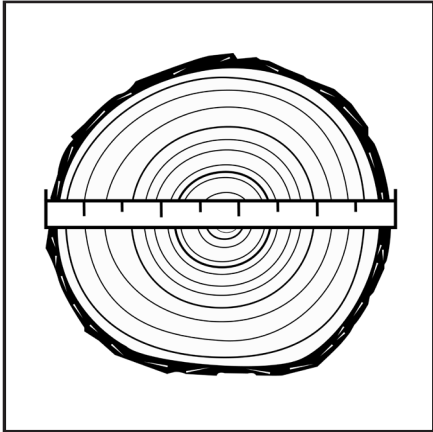

### F3: Woody Diameter Classes



Mark ALL the types that comprise >5% of the woody canopy cover in the AA or >5% of the wooded areas (if any) along its upland edge (perimeter). The edge should include only the trees whose canopies extend into the AA.

**More Details:** Estimate the diameters at 1.3 m above the tree base (about chest height). If small-diameter trees are overtopped (shaded) by larger ones, visualise a “subcanopy” at the average height of the smaller-diameter trees, to serve as a basis for the minimum 5% canopy requirement in this question. The trees and shrubs need not be wetland species.

#### Coniferous

- |   |                             |                             |                           |
|---|-----------------------------|-----------------------------|---------------------------|
| <b>A</b> 1-9 cm diameter and >1 m tall. | <b>B</b> 10-19 cm diameter. | <b>C</b> 20-40 cm diameter. | <b>D</b> >40 cm diameter. |
| <b>E</b> N/A (<1% woody cover)          |                             |                             |                           |

#### Broad-Leaved Deciduous

- |   |                             |                             |                           |
|---|-----------------------------|-----------------------------|---------------------------|
| <b>A</b> 1-9 cm diameter and >1 m tall. | <b>B</b> 10-19 cm diameter. | <b>C</b> 20-40 cm diameter. | <b>D</b> >40 cm diameter. |
| <b>E</b> N/A (<1% woody cover)          |                             |                             |                           |

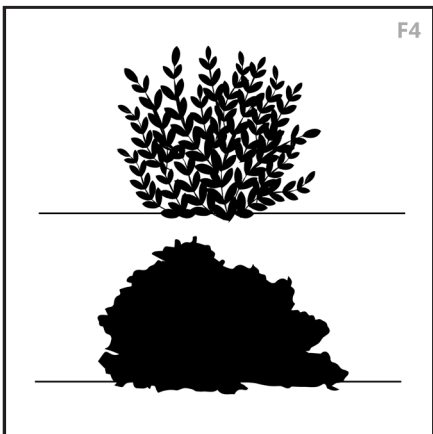

### F4 [AAvW]: Dominance of Most Abundant Shrub Genera



If <5% of the AA has short (<1m) woody cover, SELECT N/A. Otherwise, determine which two woody plant genera comprise the greatest portion of the short (<1 m) woody cover. Then choose one:

**More Details:** Estimate the percentage as a percentage of just the low (short) woody cover, not a percentage of the entire wetland. “Genera” is intended to mean readily distinguishable plant forms (e.g., willow vs. alder vs. birch), not different species within these forms.

- |  |   |
|--|---|
| <b>A</b> N/A   | <b>B</b> Those 2 genera together comprise > 80% of all low woody cover. Low woody cover is monotypic or nearly so.        |
| <b>C</b> Those 2 genera together comprise 50-80% of all low woody cover. | <b>D</b> No 2 genera together comprise > 50% of such cover. Several genera of low woody plants are significantly present. |

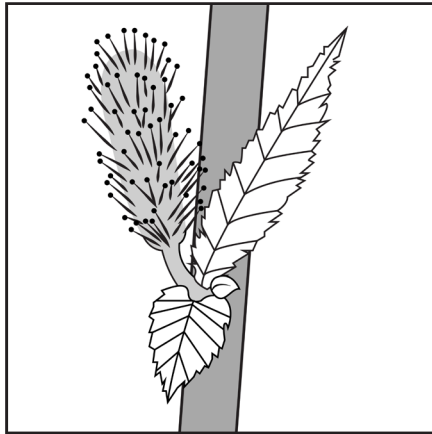

### F5 [AAv]: Tall Willow Cover



Within the AA, willows taller than 2 m comprise \_\_\_% of the vegetated cover, in the AA or along its water edge (whichever has more).

**More Details:** Vegetated cover should not include moss or aquatic plants.

- (A) <1% or none.
- (B) 1 - 25%
- (C) 26 - 50%
- (D) 51 - 75%
- (E) >75%

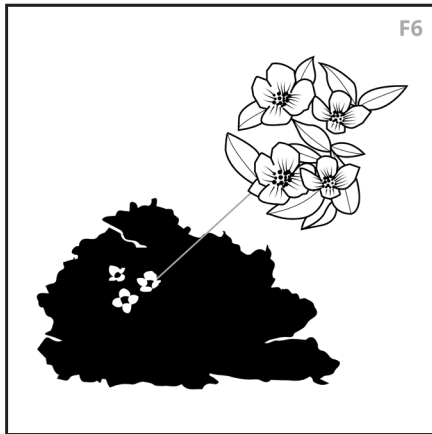

### F6 [AAv]: Flowering Shrubs



Woody plants that have flowers with conspicuous petals at some time of the year comprise \_\_\_% of the vegetated cover of the AA.

**More Details:** "Vegetated cover" should not include moss or aquatic plants. Conspicuous = flower petals that are large, prominently colored, or distinctively shaped, making them easily visible to the naked eye. Do not include species such as Salix, birch, most needle-producing shrubs.

- (A) <5% or none.
- (B) 5 - 25%
- (C) 26 - 50%
- (D) 51 - 95%
- (E) >95%

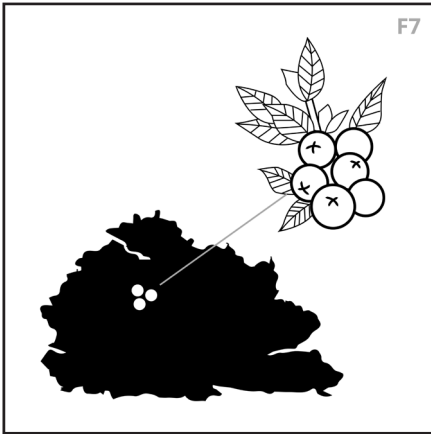

### F7 [AAv]: Berry Producing Shrubs



Woody plants that potentially produce succulent fruits or berries comprise \_\_\_% of the vegetated cover of the AA.

**More Details:** Woody plants (shrubs) that produce fleshy, high-moisture fruits which serve as critical food sources for wildlife and contribute to traditional cultural use. Examples include but are not limited to bog cranberry, lingonberry, kinnikinnick, highbush cranberry, rose hips. Excludes bunchberry.

- A <5% or none.
- B 5 - 25%
- C 26 - 50%
- D 51 - 95%
- E >95%

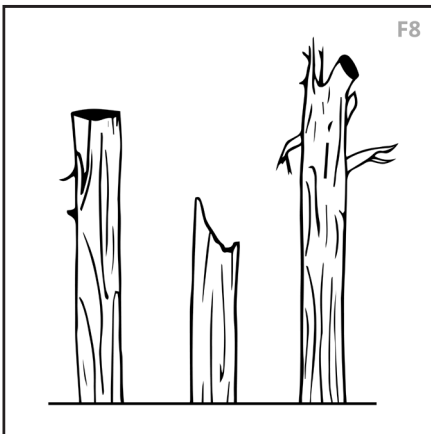

### F8 [AA + U & Aerial]: Large Snags (Dead Standing Trees)



The number of large snags (diameter >20 cm) in the AA plus adjacent upland area within 10 m of the wetland edge is:

**More Details:** Snags are dead standing trees that often (not always) lack bark and foliage. Include only ones that are > 3 m tall.

- A None, or fewer than 8/ hectare which exceed this diameter.
- B Several (>8/hectare) and a pond, lake, or slow-flowing water wider than 10 m is within 1 km.
- C Several (>8/hectare) but above not true.

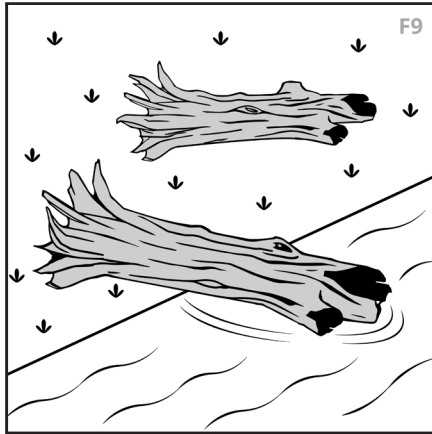

### F9 [AA]: Downed Wood



The number of downed wood pieces longer than 2 m and with diameter >10 cm, and not persistently submerged, is \_\_\_ per 10 x 10 m plot.

**More Details:** Exclude wood piled in the AA by humans, as that is a non-sustaining source.

**A** <2

**B** 2 - 8

**C** 9 - 60

**D** >61

#### F9 Visual Aid |

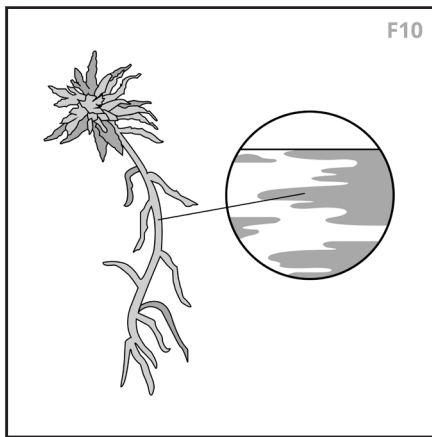
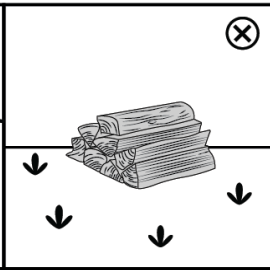
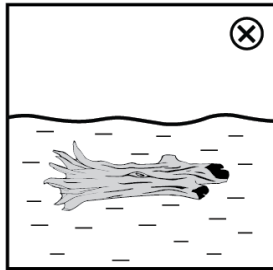
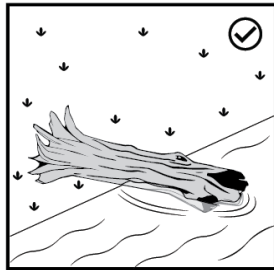

### F10 [AAv]: Dense Moss Extent



The cover of mosses that form a densely packed cushion many centimeters (>5 cm) thick (i.e., Sphagnum and other peat-forming species), including the moss obscured by taller sedges, shrubs, and other plants rooted in it, is \_\_\_% of the vegetated part of the AA.

**More Details:** Exclude moss growing on trees or rocks.

**A** <5%

**B** 5 - 25%

**C** 26 - 50%

**D** 51 - 95%

**E** >95%

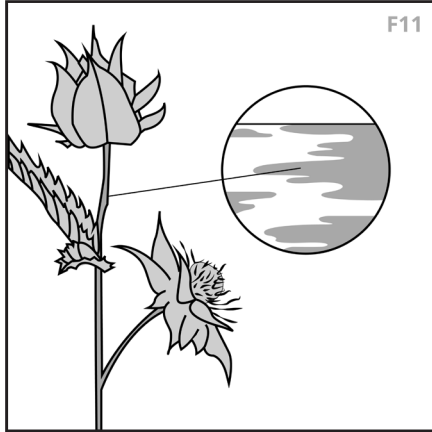

### F11 [AAv]: Flowering Forb Cover



The areal cover of forbs (plants with conspicuous flowers at any time of year) reaches an annual maximum of \_\_\_% of the vegetated part of the AA.

**More Details:** Compare with just the herbaceous part of the wetland, not the entire wetland or the entire vegetated part. Forbs are non-woody plants with conspicuous flowers. They may not be flowering at the time of your visit but most can be recognized by having broad leaves rather than blades like grasses. Include forbs hidden beneath a grass or woody canopy

as well as forbs in the open. Do not include grasses, sedges, cattail, other graminoids, ferns, horsetails, or others that do not contain conspicuous flowers at any time of year.

Conspicuous = flower petals that are large, prominently colored, or distinctively shaped, making them easily visible to the naked eye.

(A) <5%	(B) 5 - 25%	(C) 26 - 50%
(D) 51 - 95%	(E) >95%	

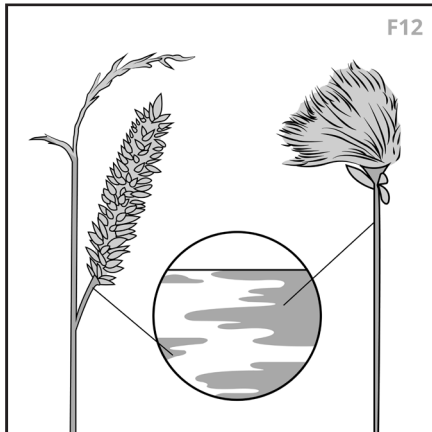

### F12: Tussock Cover



Sedges (*Carex* spp.) and cottongrass (*Eriophorum* spp.) that form tussocks (raised mounds with dense stems and deep roots) occupy \_\_\_% of the vegetated area.

**More Details:** Only include species that form dense elevated mounds where dead leaves accumulate around the base, creating a distinctive hummock. This only occurs with some carex species such as Tufted Clubbrush (*Trichophorum cespitosum*), and cottongrass species such as Tussock Cottongrass (*Eriophorum vaginatum*), Tufted hairgrass (*Deschampsia cespitosa* ssp. *cespitosa*).

(A) <5% or none	(B) 5 - 50%	(C) 51 - 95%	(D) >95%
-----------------	-------------	--------------	----------

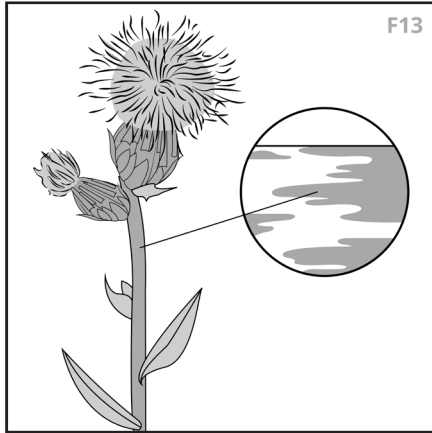

### F13 [AAv]: Invasive Plant Cover



The extent of invasive plant cover in the vegetated AA is --% of the herba- ceous cover (or woody cover, if the invasives are woody).

**More Details:** Includes species that are designated as exotic, noxious, and/or prohibited noxious. Refer to the Weed Control Act; Weed Control Regulation, Schedule A Part I (Provincial) and Part II (Regional) as applica- ble. The "BC Report Invasives App" (Android/iOS) or the invasive species library may be used as resources. These species should be documented within site notes or on associated vegetation plot data sheets.

**Critical Variable:** This attribute is a primary driver for several ecological models. Prioritize thorough site investigation and verified local knowledge; answering this question accurately is essential for reliable scoring.

- |   |   |                         |
|---|---|-------------------------|
| <p><b>A</b> Absent or only a few individuals.</p> | <p><b>B</b> &lt; 5% but more than a few individuals</p> | <p><b>C</b> 5 - 20%</p> |
| <p><b>D</b> 21 - 50%</p>                          |   | <p><b>E</b> &gt;50%</p> |

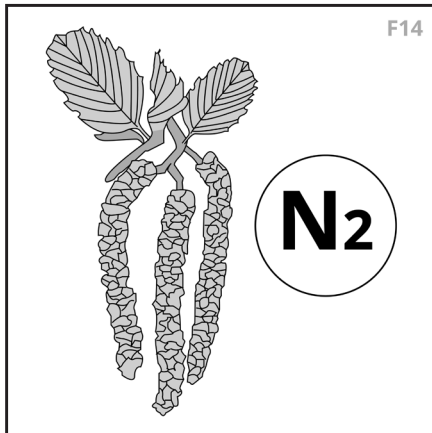

### F14 [AAv]: N Fixers



The percentage of the vegetated cover in the AA or along its water edge (whichever has more) that contains nitrogen-fixing plants is:

**More Details:** Examples of nitrogen fixing plants are alder (*Alnus* spp.), com- mon spike-rush (*Eleocharis palustris* (L.)), sweet clover (*Melilotus* spp.), sweetgale (*Myrica gale*), buffaloberry (*Shepherdiaspp.*), lupine (*Lupinus* spp.), Vetch (*Vicia* spp.) and other legumes. Do not include N-fixing algae (cyanobacteria), mosses, or lichens.

- |                                  |                         |                          |
|----------------------------------|-------------------------|--------------------------|
| <p><b>A</b> &lt; 1% or none.</p> | <p><b>B</b> 1 - 25%</p> | <p><b>C</b> 26 - 50%</p> |
| <p><b>D</b> 51 - 75%</p>         |                         | <p><b>E</b> &gt;75%</p>  |

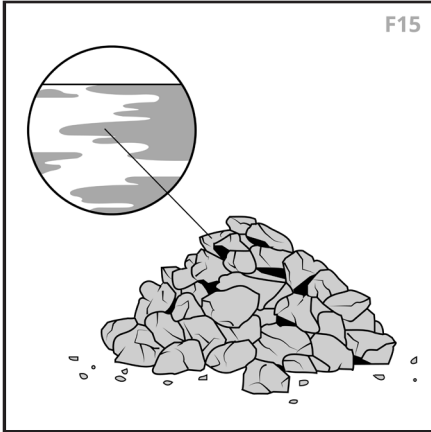

### F15 [AAv & Aerial]: % Bare Ground



The extent of bare soil or sediment at mid-summer (excluding parts not visible because underwater or snow) is:

**More Details:** Thatch is dead plant material (stems, leaves) still attached to plants or on the ground but resistant to erosion by wind and water. Bare ground present under a tree or shrub canopy should be counted. This question can be difficult to infer when areas are flooded, and should be considered using best available knowledge of low-water conditions, but in doubt should be answered based on the condition at the time of assessment

- |   |   |
|---|---|
| <p><b>A</b> Little or no (&lt;5%) bare ground is visible between erect stems or under canopy anywhere in the vegetated AA. Ground is extensively blanketed by dense thatch, moss, lichens, graminoids with great stem densities, or plants with ground-hugging foliage.</p> |   |
| <p><b>B</b> Slightly bare ground (6-15% bare between plants) is visible in places, but those areas comprise <b>less</b> than 5% of the unflooded parts of the AA.</p>   | <p><b>C</b> Much bare ground (16-50% bare between plants) is visible in places, and those areas comprise more than 5% of the unflooded parts of the AA.</p> |
| <p><b>D</b> Other conditions.</p>   | <p><b>E</b> Not applicable. Surface water (either open or obscured by emergent plants) covers all of the AA all the time.</p>                               |

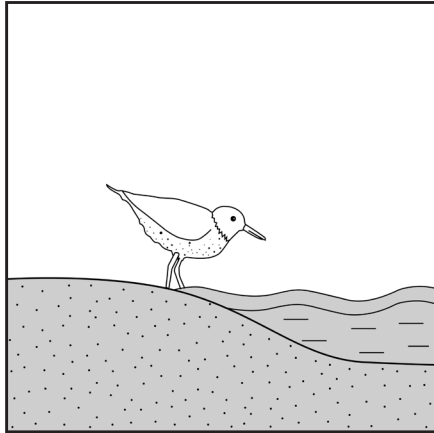

### F16 [AA & Aerial]: Shallow Open Water + Bare Saturated Substrate



During any 2 consecutive weeks of the growing season, the extent of waters that are both shallower than 5 cm and not shaded by vegetation, added to areas that have bare saturated substrate (e.g., mudflat) that have sparse or no vegetation canopy, are:

**More Details:** 0.01 ha = 10m x 10m, .10 ha= 100m x 10m, 1.00 ha = 100m x 100m.

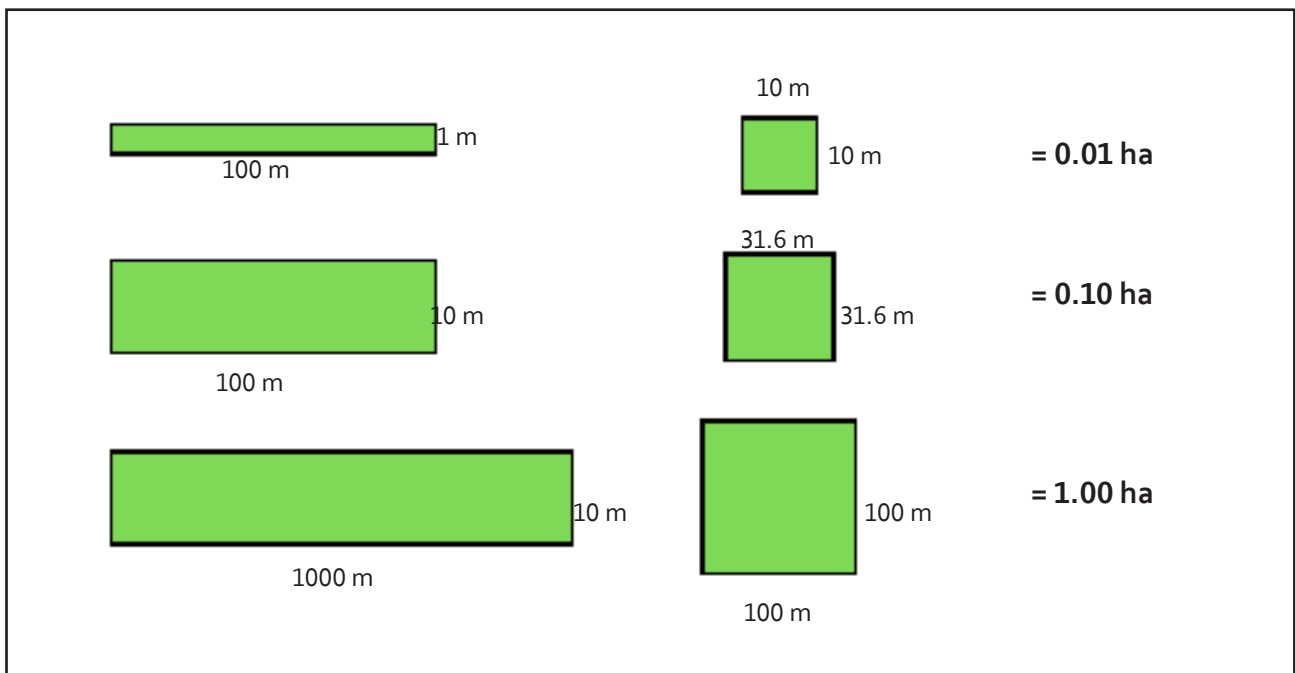

**A** none, or <10 sq. m.

**B** 10 - 100 sq. m.

**C** 0.01 - 0.1 hectares (e.g., at least a 100-m long strip >1 m wide)

**D** 0.10 - 1 hectare (e.g., at least a 100-m long strip >10 m wide)

**E** >1 hectare (e.g., at least a >1000-m long strip >10 m wide)

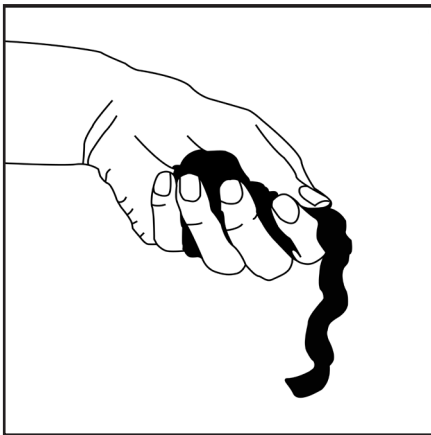

### F17 [AAv]: Soil Surface Texture



In parts of the AA that lack persistent surface water, the texture of soil in the uppermost layer is mostly:

**More Details:** Use a trowel or shovel to check the surface soil layer in at least 3 widely spaced locations along an elevation gradient within the wetland. 40 cm

(16 inches) is the usual limit of the rooting zone of most wetland herbaceous plants. If soil disturbance is not permitted due to archaeological concerns, make an estimate based on naturally exposed soil. The uppermost layer refers measuring the beginning of the A horizon (below the LFH in mineral soils) and from the surface in Organic soils. "Organic" includes muck, mucky peat, and mucky mineral soils. Do not include duff (LFH materials). "Surface" organic layers should begin where organic matter (if any) is mostly decomposed and living roots become scarce. An exception is peat soils, where the "surface" layer would usually begin immediately at the air interface with living moss.

**A** **Loamy:** soils that may contain a little fine grit and do not make a "ribbon" longer than 2 cm when moistened, rolled, squeezed, and extended between thumb and forefinger

**B** **Fines:** includes silt and clay soils that make a ribbon longer than 2 cm when moistened, rolled, squeezed, and extended between thumb and forefinger.

**C** **Coarse:** includes sand, loamy sand, gravel, cobble; soils that do not make a ribbon when moistened, rolled, squeezed, and extended between thumb and forefinger.

**D** **Organic to depth of  $\geq 40$  cm.**

**E** **Organic to  $< 40$  cm depth.**

**F** **Soil not accessible.**

### F17 Visual Aid |

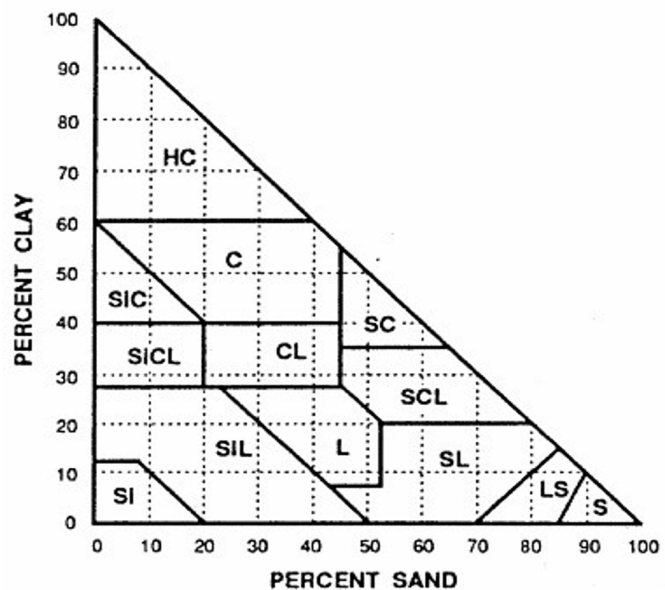

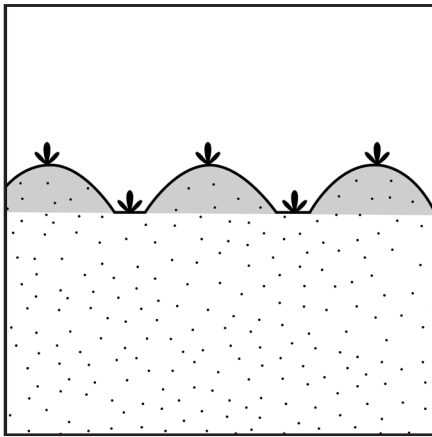

### F18 [AAv]: Microtopography (Ground Irregularity)



Imagine the AA without any living vegetation (other than moss, if any). Excluding the portion of the AA that is always under water, the amount of hummocks, small pits, raised mounds, animal burrows, ruts, gullies, natural levees, microdepressions, and other areas of peat or mineral soil that are raised or depressed >10 cm compared to most of the area within a few meters surrounding them is:

**More Details:** The depressions may be of human or natural origin.

**A** Few or none (minimal microtopography; <1% of the land has such features, or the entire AA is always water-covered).

**B** Intermediate.

**C** Several (extensive micro-topography, >25% of the land).

F18 Visual Aid |

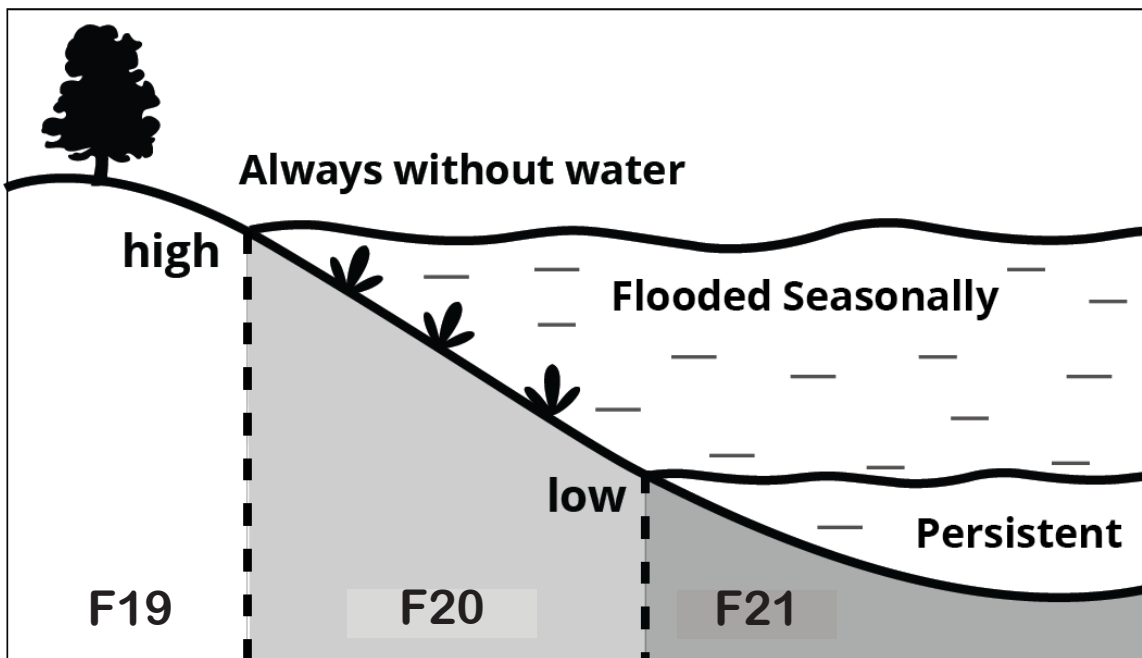
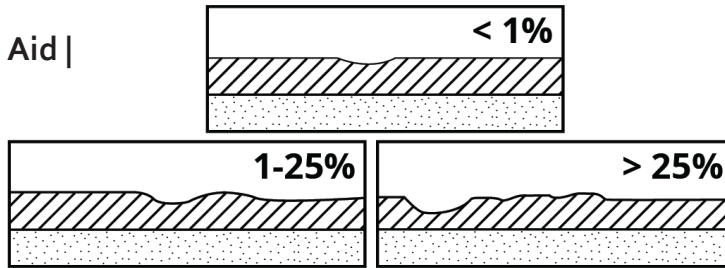

**Step 1:** Using historic imagery, local knowledge and indicators of high and low water marks (eg staining on trees, exposed mudflat, water staining etc.), determine the high and low water levels as best as possible, with reference to the entire delineated wetland.

**Step 2:** divide the wetland into three zones, such as to match diagram below:

- i. F 19 - the portion of the wetland that never has surface water, but is still a wetland/within the AA polygon.
- ii. F 20 - Seasonal range of surface water in the wetland. The zone that is covered by water in the most flooded annual average conditions, and dry during the period with lowest water.
- iii. F 21 - Persistently flooded: area of the wetland that has surface water for the entire growing season, most years

**Step 3:** using aerial imagery or mapping estimate the % cover of each zone. These percentages must add up to 100%. There should not be overlap of these zones.

**Step 4:** use the percentage covers from step 3 to choose the appropriate choice for each of the following questions.

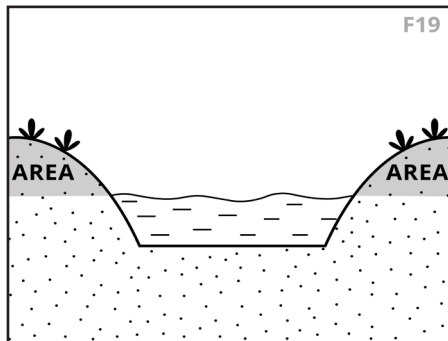

**F19 [AA & Aerial]: % Always WITHOUT Surface Water**



The percentage of the AA that never contains surface water during an average year (that is, except perhaps for a few hours after snowmelt or rainstorms), but which is still a wetland, is:

**More Details:** This addresses areas where the soils remain saturated for much of the year despite never being covered by surface water. Such areas are mostly along the wetland's boundary with the upland and are distinguished from upland (non-wetland) by hydric soil indicators and/or the predominance of wetland-indicator plant species.

**A** <1%. In other words, all or nearly all of the AA is covered by water permanently or at least seasonally.

**C** 21 - 50%

**E** 76-99%, or >99% AND there is at least one persistent or seasonal water body larger than 0.01 hectare (e.g., 10m x 10m) in the AA.

**B** 1-20% of the AA, or <1% but >0.01 hectare (e.g., 10m x 10m) never contains surface water.

**D** 51 - 75%

**F** 99-100%. AND there is no persistent or seasonal water body larger than 0.01 hectare in the AA. Enter "1" and SKIP to F40

**Critical Variable:** This attribute is a primary driver for several ecological models. Prioritize thorough site investigation and verified local knowledge; answering this question accurately is essential for reliable scoring.

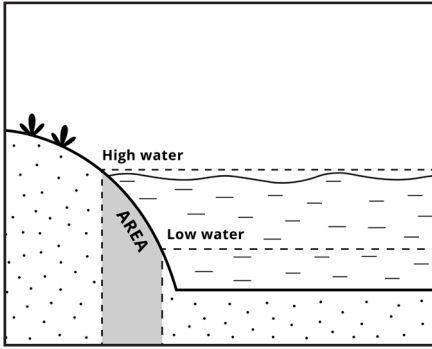

### F20 [AA & Aerial]: % Flooded ONLY Seasonally



The percentage of the AA's area that is between the annual high water and the annual low water (surface water) is:

**More Details:** Look for flood marks including litter suspended in shrubs; water lines or ice scour lines on trees, rocks, or structures; bleaching at the bases of tall herbaceous plants; adventitious roots; matted vegetation. If possible ask land owner or neighbors about water extent during wettest and driest times of most years. In riverine systems, the extent of this zone can be roughly estimated by multiplying the bankful height by 2 and visualizing where that would intercept the land along the river. Areas that flood only seasonally often have a larger proportion of upland and annual (vs. perennial) plant species. User-friendly commercial software is available that can quantify seasonal and annual variation in any wetland based on analysis of multiple existing aerial images that may not otherwise be accessible to the user.

**A** None, or < 0.01 hectare and < 1% of the AA.

**B** 1 - 20% or < 1% but > 0.01 hectare.

**C** 21 - 50%

**D** 51 - 95%

**E** < 95%

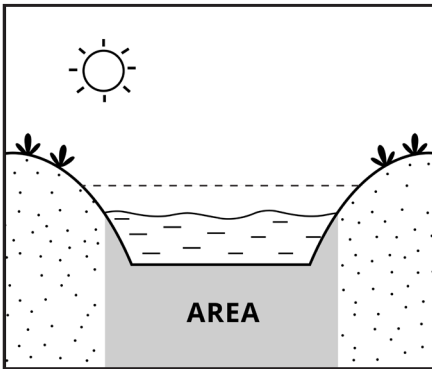

### F21 [AA & Aerial]: % with Persistent Surface Water



Identify the parts of the AA that still contain surface water (flowing or ponded, open or hidden beneath vegetation) even during the driest times of a normal year, i.e., when the AA's surface water is at its lowest annual level. At that time, the percentage of the AA that still contains surface water is:

**More Details:** Water persistence is suggested by the presence of biological indicators, which may include fish, some dragonfly taxa, submerged aquatic plant species, beavers, and muskrats, although none of these alone is definitive. Cross-reference with historic imagery, such as Google Earth Timelapse or locally available air photos, to answer this question.

**A** None, and the entire AA lacks surface water during most years (except for a few hours after storms, brief river flooding, or snowmelt).

**B** None, but parts of the AA have surface water for >3 consecutive weeks during most years.

**C** 1 - 20%

**D** 21 - 50%

**E** 51 - 95%

**F** < 95%

**Critical Variable:** This attribute is a primary driver for several ecological models. Prioritize thorough site investigation and verified local knowledge; answering this question accurately is essential for reliable scoring.

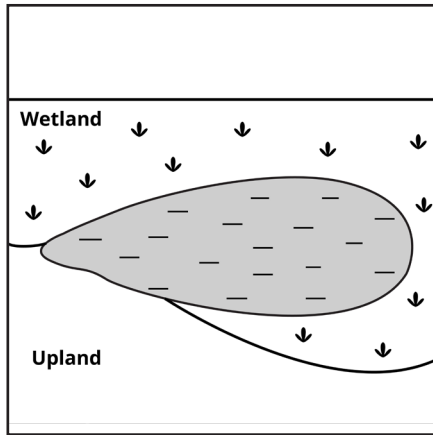

### F22 [AA & Aerial]: Fringe Wetland



During most of the year, is open water (>2m deep) within or abutting the vegetated part of the wetland.

**More Details:** As used herein, “abutting” means no upland (artificial or natural) completely separates the described features (open water and vegetation) along their directly shared edge. “Open water” is not vegetated with submerged or floating aquatics, and is typically > 2m deep.

(A)	Yes	(B)	No
-----	-----	-----	----

### F22 Visual Aid |

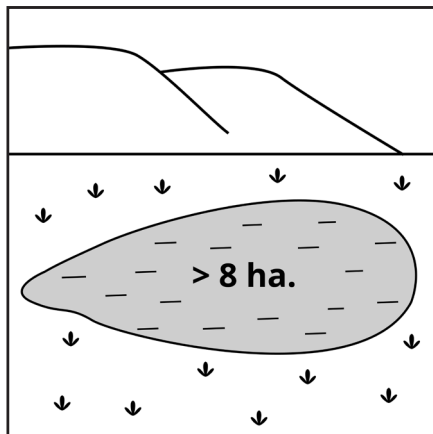
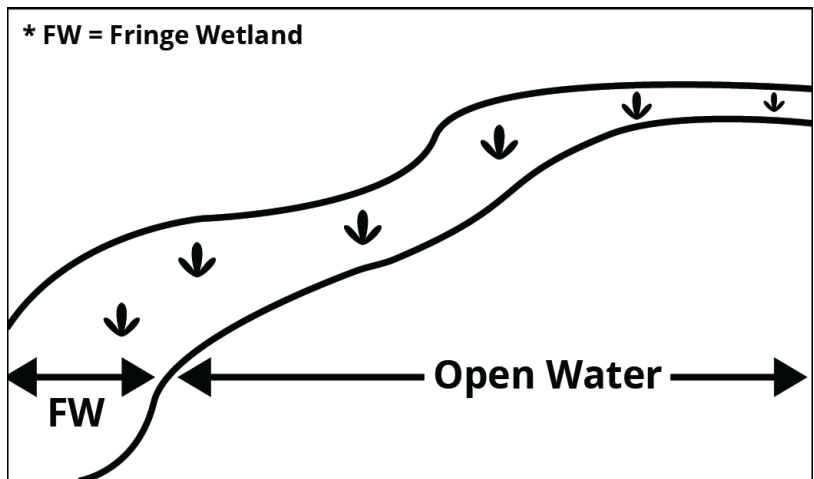

### F23 [AA & Aerial]: Lacustrine Wetland



Is the vegetated part of the AA within or abutting a body of standing open water whose size exceeds 8 hectares during most of a normal year?

**More Details:** Consult aerial images for open water.

(A)	Yes	(B)	No
-----	-----	-----	----

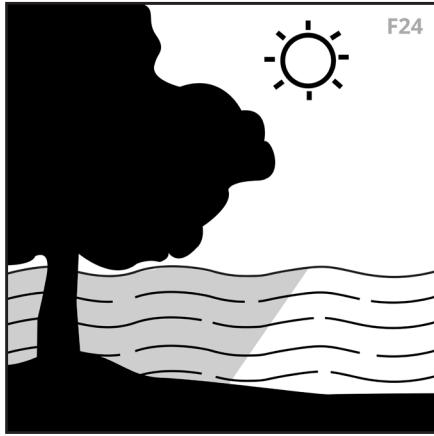

F24

### F24 [AAH]: % of Summertime Water that is Shaded



At mid-day during the warmest time of year, the amount of surface water within the AA that is shaded by vegetation and other features that are within the AA at that time is \_\_\_% of the total surface water:

**More Details:** "Vegetation" includes herbaceous plants as well as woody, including floating-leaved vegetation other than moss or algae mats. Note that even areas that appear to have a continuous canopy of grasslike plants contain spaces between plants that would not be shaded by those plants during the specified time (mid-day).

**A** < 5%, or no surface water is present then.

**B** 5 - 25 %

**C** 26 - 50%

**D** 51 - 75%

**E** > 75%

#### F24 Visual Aid |

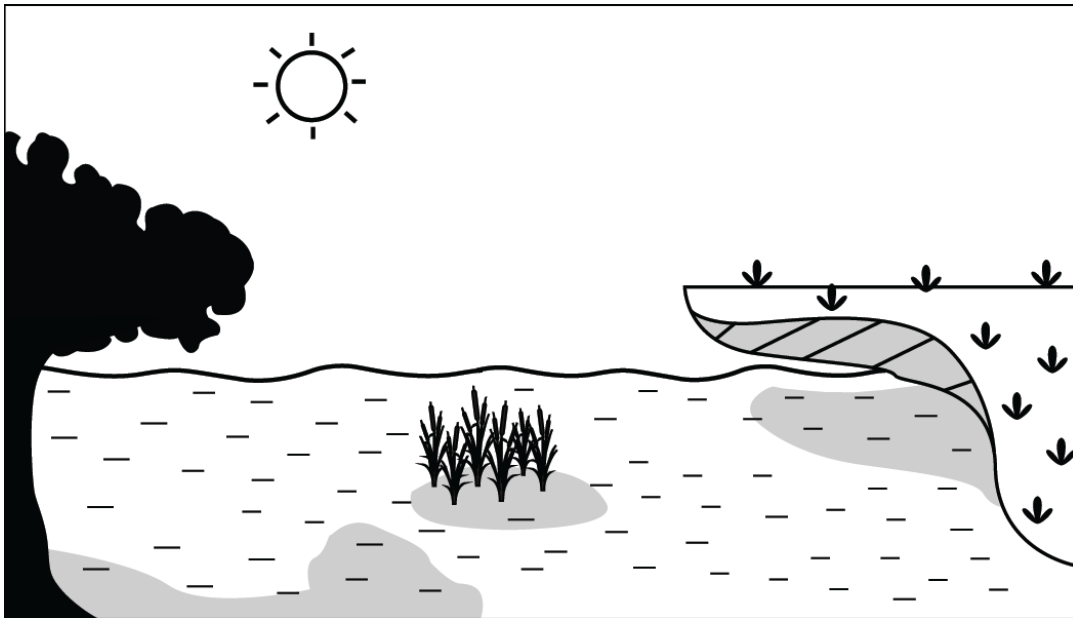

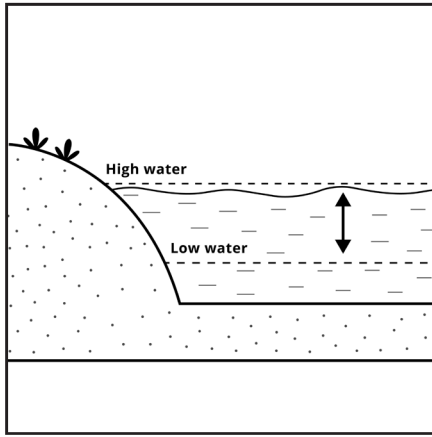

### F25 [AAh]: Surface Water Fluctuation Range



The annual vertical fluctuation in unfrozen surface water within most of the parts of the AA that contain surface water at least temporarily is:

**More Details:** Look for flood marks (see F20). Because the annual range of water levels is difficult to estimate without multiple visits, consider asking the land owner or neighbors about it.

**A** < 10 cm change  
(stable or nearly so)

**B** 10 cm - 50 cm change

**C** > 0.5 - 1 m change

**D** 1 - 2 m change

**E** > 2 m change

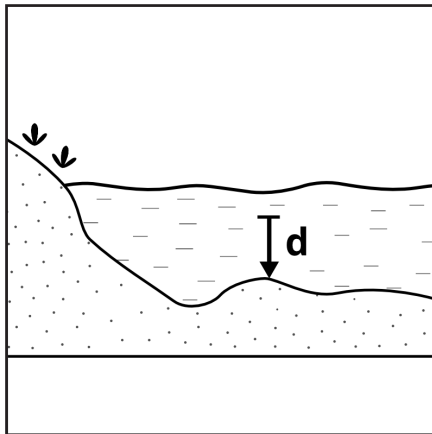

### F26 [AAh]: Predominant Depth Class



During most of the time when surface water is present during the growing season, its depth in most flooded areas of the AA is:

**More Details:** This question is asking about the spatial median depth that occurs during most of that time, even if inundation is only seasonal or temporary. If inundation in most but not all of the wetland is brief, the answer will be based on the depth of the most persistently inundated part of the wetland. Include surface water in channels and ditches as well as ponded areas. If a boat is unavailable, also estimate this by considering wetland size and local topography. Or if timing and safety allow, depths may be measured by drilling through winter ice.

**A** < 10 cm deep  
(but > 0)

**B** 10 cm - 50 cm deep

**C** > 0.5 - 1 m deep

**D** 1 - 2 m deep

**E** > 2 m deep. True for many fringe wetlands

**Critical Variable:** This attribute is a primary driver for several ecological models. Prioritize thorough site investigation and verified local knowledge; answering this question accurately is essential for reliable scoring.

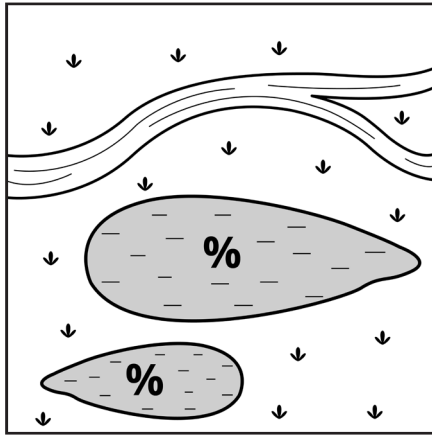

### F27 [AAh]: Ponded Water



During most times when surface water is present, the percentage -- with or without inundated vegetation -- that is ponded (stagnant, or flows so slowly that fine sediment is not held in suspension) is:

- |  |  |  |
|--|--|--|
| <p><b>A</b> &lt;1%. Nearly all of the surface water is flowing when it is present. IF SELECTED SKIP TO F31 (Open Water).</p> | <p><b>B</b> 1 - 4%. Most of the surface water is flowing when it is present.</p> | <p><b>C</b> 5 - 30%. Most of the surface water is flowing when it is present.</p>      |
| <p><b>D</b> 31 - 70%. Most of the surface water is ponded when it is present.</p>  | <p><b>E</b> 71-95%. Most of the surface water is ponded when it is present.</p>  | <p><b>F</b> &gt;95%. Nearly all of the surface water is ponded when it is present.</p> |

**More Details:** Consult historic imagery to answer this question such as google earth timelapse, or locally available air photos.

**Critical Variable:** This attribute is a primary driver for several ecological models. Prioritize thorough site investigation and verified local knowledge; answering this question accurately is essential for reliable scoring.

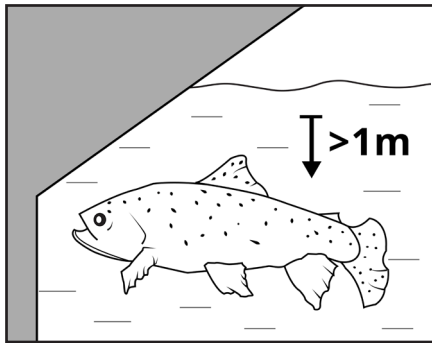

### F28 [AAh]: Non-Vegetated Aquatic Cover



During most of the growing season the cover for fish and amphibians that is provided NOT by living vegetation, but by accumulations of partly-submerged dead wood thicker than 10 cm, undercut banks, and/or fish-accessible water deeper than 1 m is:

**More Details:** Wood that is underwater cannot be reliably evaluated from dry land, so base your estimate only on what you can see clearly from dry land.

- |   |   |  |
|---|---|--|
| <p><b>A</b> Little or none, or all water is shallower than 1 m most of the year, or less than 1% incised banks.</p> | <p><b>B</b> Intermediate - e.g., between 3-8 pieces of wood per reach, or between 1-10% incised bank.</p> | <p><b>C</b> Extensive. - &gt;8 pieces of wood per reach (reach = 10x channel width), or &gt;10% of bank incised.</p> |
|---|---|--|

#### F28 Visual Aid |

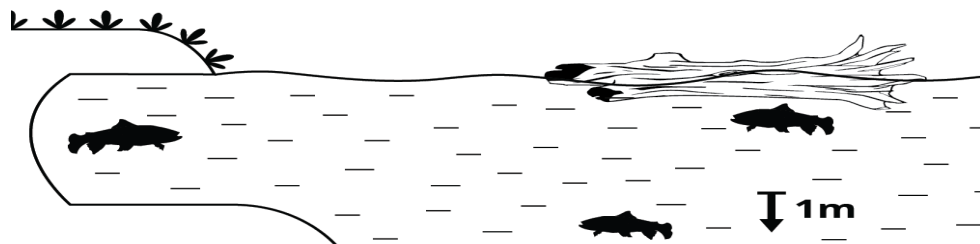

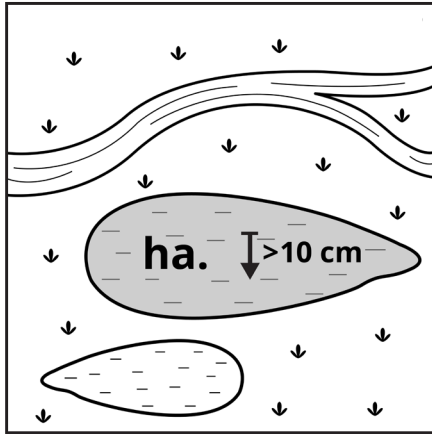

### F29 [AA + Ah & Aerial]: Largest Deep Poned Water (as hectarage)



Within or abutting the AA, the largest ponded surface water patch, with or without inundated vegetation, that remains flooded to a depth of >10 cm for at least 3 consecutive weeks during the usual growing season comprises:

**Critical Variable:** This attribute is a primary driver for several ecological models. Prioritize thorough site investigation and verified local knowledge; answering this question accurately is essential for reliable scoring.

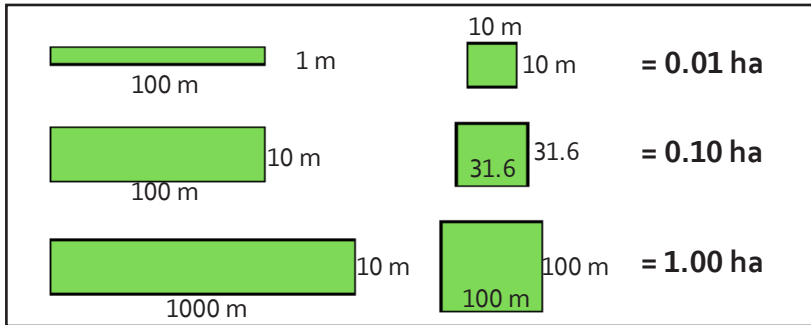

**A** none, or <100m<sup>2</sup>

**B** 0.01 - 0.10 ha (e.g., at least a 100-m long strip >1 m wide)

**C** 0.10 - 1.00 ha (e.g., at least a 100-m long strip >10 m)

**D** 1 - 10 ha (e.g., at least a >1000-m long strip >10 m)

**E** 10 - 100 ha

**F** > 100 ha

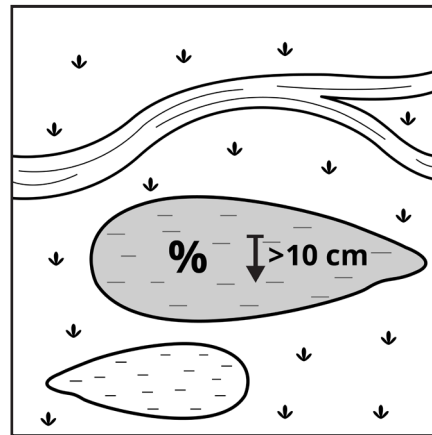

### F30 [AA + Ah & Aerial]: Largest Deep Poned Water (as percentage of the AA)



Within the AA, the largest ponded surface water patch, with or without inundated vegetation, that remains flooded to a depth of >10 cm for at least 3 consecutive weeks during the usual growing season comprises:

**A** <1% of the AA and <0.01 ha. IF SELECTED SKIP to F37

**B** 1-4% of the AA, or <1% of the AA but >0.01 ha.

**B** 5 - 30%

**D** 31 - 70%

**E** 71 - 99%

**F** 100%

**Critical Variable:** This attribute is a primary driver for several ecological models. Prioritize thorough site investigation and verified local knowledge; answering this question accurately is essential for reliable scoring.

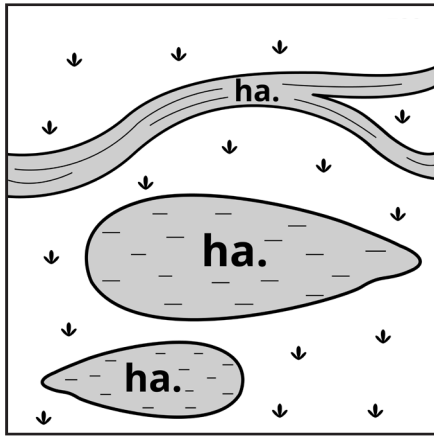

### F31 [AA + Ah & Aerial]: Open Water Extent



Including any open water abutting the AA, the summed area of all patches with open water (ponded or flowing) during most of the growing season.

**More Details:** From an aerial (“duck’s eye”) view, consider all open water not obscured by vegetation. Open water can include vascular plants that are floating or submerged aquatics (such as lily pads or bladderwort), but not moss (such as a floating fen). For fringe wetlands include all of the abutting water, consider not only the water in the AA, but also the adjacent open water. Consult aerial imagery to calculate these areas.

**Critical Variable:** This attribute is a primary driver for several ecological models. Prioritize thorough site investigation and verified local knowledge; answering this question accurately is essential for reliable scoring.

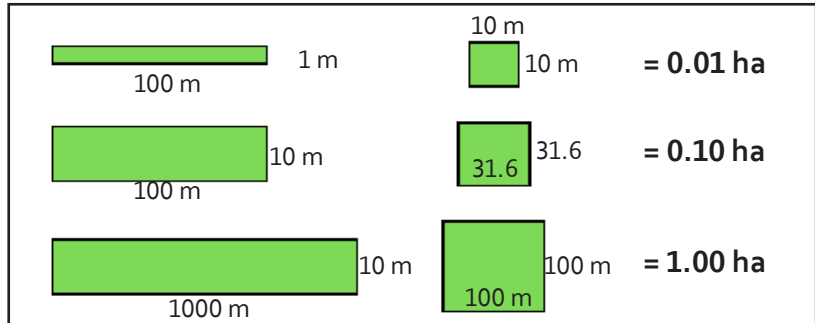

- |   |   |  |
|---|---|--|
| <b>A</b> none, or <100m <sup>2</sup><br>IF SELECTED SKIP to F37           | <b>B</b> 0.01 - 0.10 ha (e.g., at least a 100-m long strip >1 m wide) | <b>C</b> 0.10 - 1.00 ha (e.g., at least a 100-m long strip >10 m wide) |
| <b>D</b> 1 - 10 hectares (e.g., at least a >1000-m long strip >10 m wide) | <b>E</b> 10 - 100 hectares  | <b>F</b> > 100 hectares  |

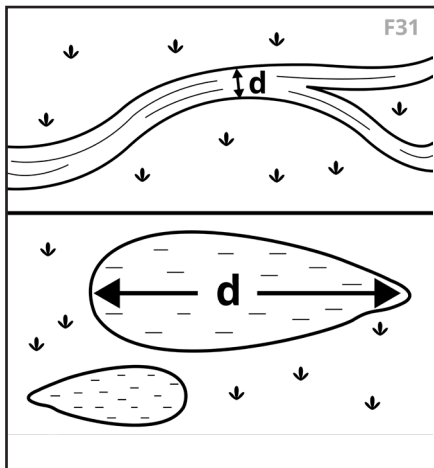

### F32 [AA + Ah]: Distance Across Longest Open Water (Fetch)



Most of the time when surface water is present, the direct distance (fetch) measured along the longest dimension of open ponded water in the AA (or channel width if there is no ponded water) and possibly extending into any abutting waters is:

- |                       |                       |                      |
|-----------------------|-----------------------|----------------------|
| <b>A</b> <10 m.       | <b>B</b> 10 - 30 m.   | <b>C</b> 31 - 100 m. |
| <b>D</b> 101 - 200 m. | <b>E</b> 201 - 500 m. | <b>F</b> > 500 m.    |

**More Details:** As used herein, “abutting” means no upland (artificial or natural) completely separates the described features (open water and vegetation) along their directly shared edge.

**Critical Variable:** This attribute is a primary driver for several ecological models. Prioritize thorough site investigation and verified local knowledge; answering this question accurately is essential for reliable scoring.

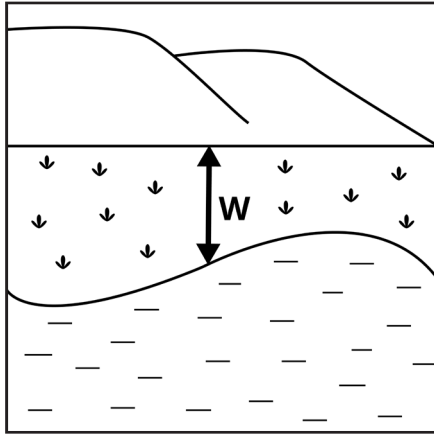

**F33 [AAv & Aerial]: Distance from Open Water to Upland (Vegetated Width)**



At the time during the growing season when the AA's water level is lowest, the average width that separates adjoining uplands from edge of open water within the AA

**A** <1 m.

**B** 1 - 9 m.

**C** 10 - 30 m.

**D** 31 - 50 m.

**E** 51 - 100 m.

**F** > 100 m, or open water is absent at that time.

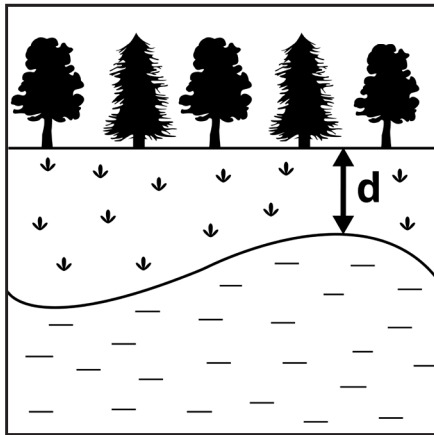

**F34 [AA +U & Aerial]: Distance from Open Water to Tall & Dense Woody Cover**



Most of the time when surface water is present, the distance from the edge of the largest body of open water within the AA to the nearest sizeable stand of tall dense woody cover (>1 ha, >2 m tall, >60% crown closure), either in the wetland or in upland, is:

**A** <10 m.

**B** 10 - 30 m.

**C** 31 - 100 m.

**D** 101 - 200 m.

**E** 201 - 500 m.

**F** > 500 m.

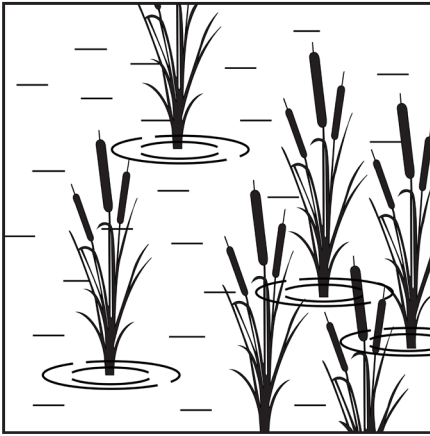

### F35 [AAh & Aerial]: Interspersion of Inundated Vegetation & Open Water

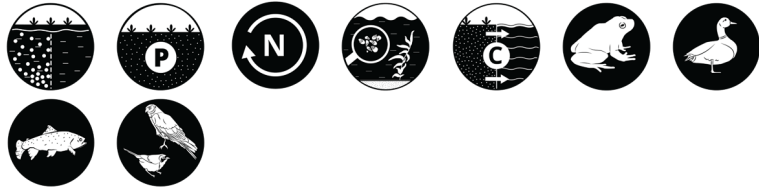

During most of the part of the growing season when surface water is present, the spatial pattern of inundated vegetation within the open water (or the open water within the vegetation) is mostly:

**A** Scattered. More than 30% of the inundated vegetation forms small islands or corridors surrounded by water, or more than 30% of the open water is in patches scattered widely amidst the vegetation.

**B** Intermediate.

**C** Clumped. More than 70% of the inundated vegetation is in rings surrounding open water or is clumped at one or a few sides of the open water areas.

**D** Uniform. There is almost no open water, or almost no vegetation.

#### F35 Visual Aid |

Scattered

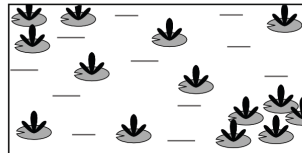

Clumped



Intermediate



Uniform

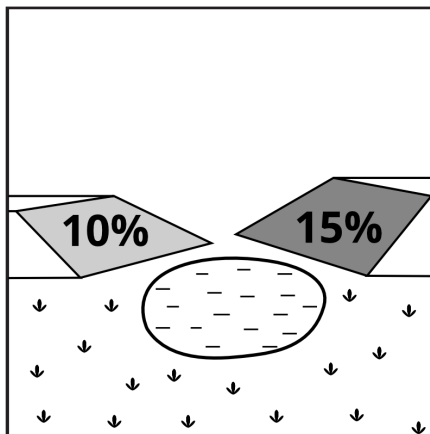
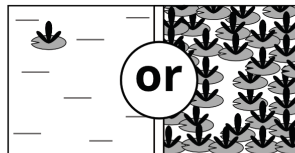

### F36 [AAh]: Steep Shoreline Extent



During most of the part of the growing season when water is present, the percentage of the AA's water edge length that is abutted by steep (>30% slope) unvegetated banks that are >1 m high is:

**A** < 1%

**B** 1 - 25%

**C** 26 - 50%

**D** 51 - 75%

**E** > 75%

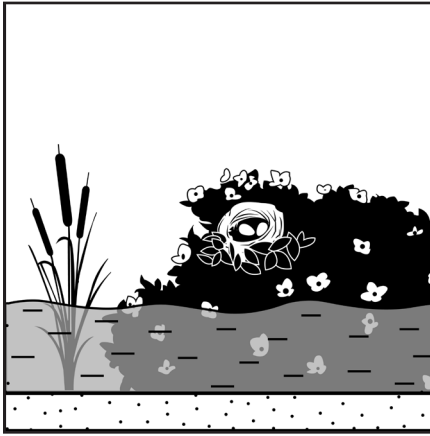

### F37 [AA + Aerial]: Inundated Erect Vegetation



The percentage of the AA that contains sedge tussocks, tall bulrush, cattail, or living woody vegetation that remains partially underwater for more than 2 weeks of the growing season annually is:

**More Details:** Erect vegetation does not include submerged or floating-leaved aquatic species that live mostly underwater or on the water surface.

- |               |                  |                   |                   |                   |                |
|---------------|------------------|-------------------|-------------------|-------------------|----------------|
| <b>A</b> < 1% | <b>B</b> 1 - 20% | <b>C</b> 21 - 40% | <b>D</b> 41 - 60% | <b>E</b> 61 - 90% | <b>F</b> > 90% |
|---------------|------------------|-------------------|-------------------|-------------------|----------------|

### F36 Visual Aid |

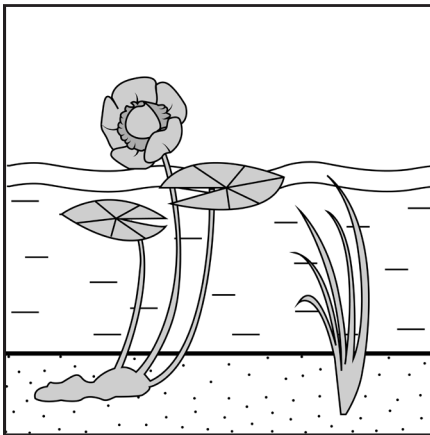
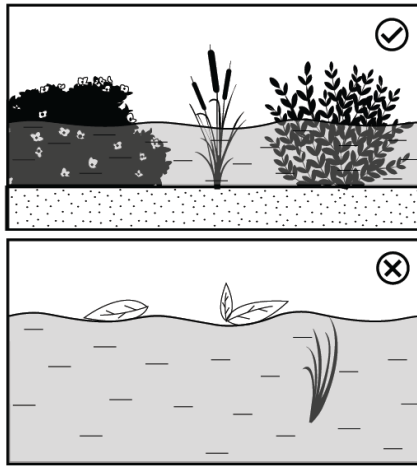

### F38 [AAh]: Submerged & Floating-leaved Aquatics



Aquatic vascular plants that live mostly underwater or on the water surface.

- |  |   |                           |
|--|---|---------------------------|
| <b>A</b> Present, and are so extensive that they choke most channels or open water areas in late summer. | <b>B</b> Present, but not choking most channels or open water areas in late summer. | <b>C</b> Absent or trace. |
|--|---|---------------------------|

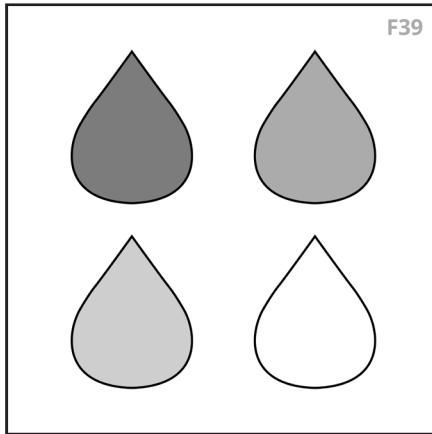

F39

### F39 [AAh]: Water Colour



The appearance of surface water that enters the AA and is most prevalent during the growing season is:

- A** Clear or slightly cloudy
- B** Stained Reddish-brown
- C** Densely cloudy
- D** Indeterminate (surface water absent at time of visit)

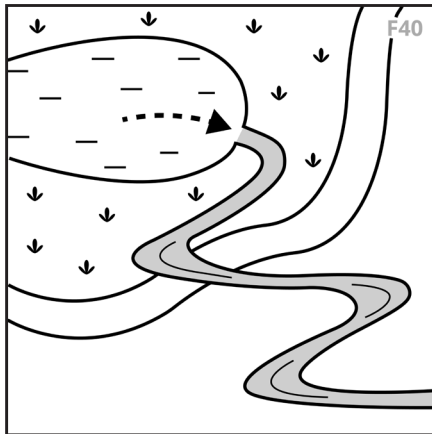

F40

### F40 [AA & Topo]: Channel Connection & Outflow Duration



The most persistent surface water connection (outlet channel or pipe, ditch, or overbank water exchange) between the AA and a downslope stream network is:

- A** Persistent (surface water flows out during the entire growing season, most years).
- B** Seasonal (surface water flows out for >3 consecutive weeks but not for the entire growing season, most years).
- C** Temporary (surface water flows out for <3 consecutive weeks,
- D** None -- but maps show a stream network downslope from the AA and within a distance that is less than the AA's longest dimension. SKIP to F45 (pH Measurement).
- E** No surface water flows out of the wetland except possibly during extreme events (<once per 10 years). Or, water flows only into a wetland, ditch, or lake that lacks an outlet. SKIP to F45 (pH Measurement).

**More Details:** If a perennial channel does not intersect or abut the AA, look for areas with seasonal or temporary outflow at the lowest elevation of the AA. The "downslope stream network" could consist of ditches, rivers, ponds, or lakes which eventually connect to the ocean, not to a closed depression. If this cannot be determined while visiting the AA, consult a topographic map. If the AA represents only part of a wetland, answer this according to whichever is the least permanent surface connection: the one between the AA and the rest of the wetland, or the surface connection between the wetland and the downslope stream network.

**Critical Variable:** This attribute is a primary driver for several ecological models. Prioritize thorough site investigation and verified local knowledge; answering this question accurately is essential for reliable scoring.

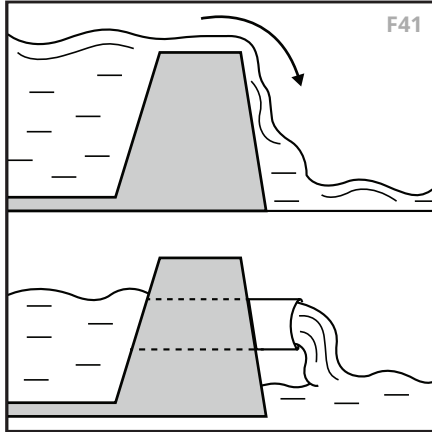

F41

### F41 [AA & Aerial]: Outflow Confinement & Artificial Drainage



During major runoff events, in the places where surface water exits the AA or connected waters nearby, the water:

**More Details:** “Major runoff events” would include biennial high water caused by storms and/or rapid snowmelt.

**A** Is exported more slowly because a substantial volume must pass through a pipe, culvert, narrowly breached dike, berm, beaver dam, or other partial obstruction (other than natural topography) that does not appear to drain the wetland artificially during most of the growing season.

**B** Leaves through natural exits (channels or diffuse outflow) or is otherwise unaffected by artificial or temporary features.

**C** Is exported more quickly than usual due to ditches or pipes within the AA, connected to its outlet, or within 30 ft of the AA’s edge, which drain the wetland artificially; or, water pumped out of the AA.

**D** Unknown because the wetland outlet could not be viewed or its type inferred.

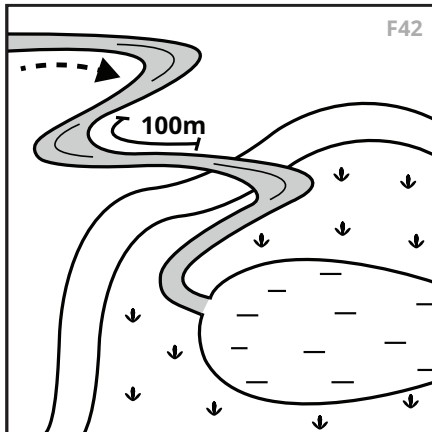

F42

### F42 [AA]: Tributary Channel of Floodplain



Surface water from a tributary channel that is >100 m long flows into the AA for >3 consecutive weeks most years (seasonal or perennial input). Or, surface water from a larger permanent water body abutting the AA spills or backs into the AA for at least 2 consecutive days most years. If it enters only via a pipe, that pipe must be fed by a mapped stream or lake. If no, SKIP to F45 (pH Measurement).

**A** Yes

**B** No

**More Details:** Where there is a suspected inlet tributary, look to see if there are continuous defined banks and signs of alluvial material (sand, gravel, cobble) in the channel. Channels may go sub-surface then reappear, but the presence of a defined channel indicates steady flow for at least a portion of the year. If inlet tributaries cannot be searched for due to inaccessibility of part of the AA, follow suggestions in F40 above.

**Critical Variable:** This attribute is a primary driver for several ecological models. Prioritize thorough site investigation and verified local knowledge; answering this question accurately is essential for reliable scoring.

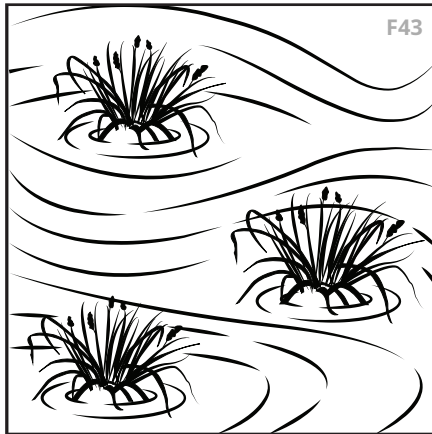

F43

### F43 [AAh & Aerial]: Throughflow Resistance



During its travel through the AA at the time of peak annual flow, water arriving in channels:

[select only the ONE statement encountered by most of the incoming water].

**A** Does not bump into many plant stems as it travels through the AA. Nearly all of the water continues to travel in unvegetated (often incised) channels that have minimal contact with wetland vegetation, or through a zone of open water such as an instream pond or lake.

**B** Bumps into **herbaceous** vegetation but mostly remains in **fairly straight** channels or flow paths.

**C** Bumps into **herbaceous** vegetation and mostly **spreads throughout**.

**D** Bumps into **tree trunks and/or shrub stems** but mostly remains in **fairly direct** flow paths.

**E** Bumps into **tree trunks and/or shrub stems** and follows a fairly **indirect** path from entrance to exit, largely spreading into wooded parts of the AA.

### F43 Visual Aid |

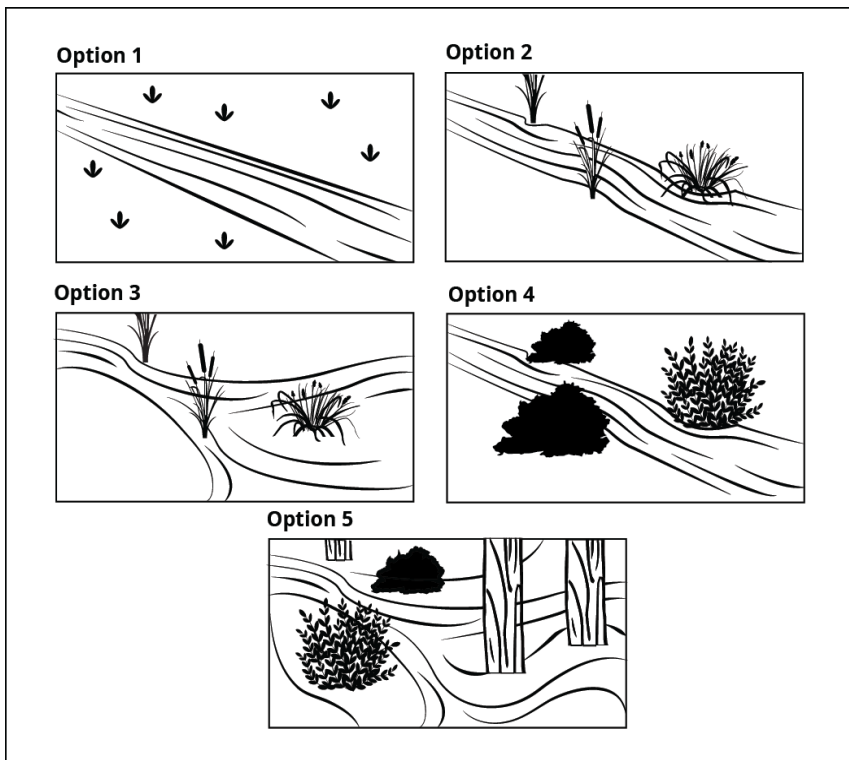

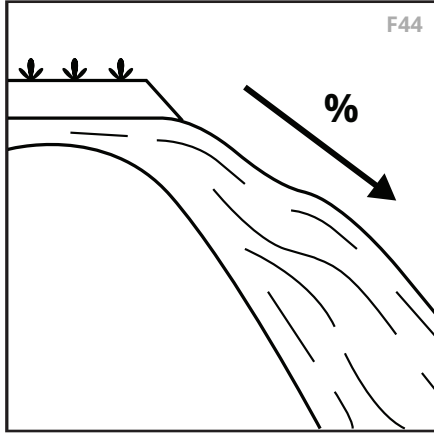

### F44 [AA & Topo]: Internal Gradient



The gradient along most of the flow path (in channel or as diffuse runoff or seepage) within the AA is:

**More Details:** This is not the same as the shoreline slope. It is the elevational difference between the AA's inlet and outlet, divided by the flow-distance between them and converted to percent. If available, use a clinometer to measure this. A free clinometer app can be downloaded to smartphones. If the wetland is large (longer than ~1 km.), this may be estimated using Google Earth to determine the minimum and maximum elevation within the AA, then dividing by length and multiplying by 100.

**A** <2% or the AA has no surface water outlet (not even seasonally).

**B** 2 - 5%.

**C** 6 - 10%.

**D** > 10%

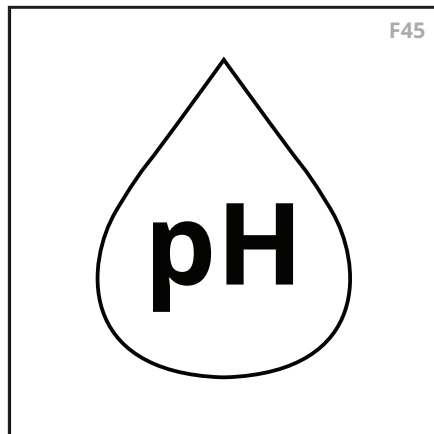

### F45: pH Measurement



The pH in most of the AA's surface water:

**More Details:** Measure this in larger areas of ponded surface water within the AA, or in streams that have passed through (not along) most of the AA. Unless surface water is completely absent, do not dig holes or make depressions in peat in order to provide water for this measurement. Avoid measuring near roads or in puddles formed only by recent rain.

**A** Was measured, and is:  
[enter the reading]

**B** Was not measured but wetland is dominated by plants characteristic of acidic conditions.

**C** Neither of the above.

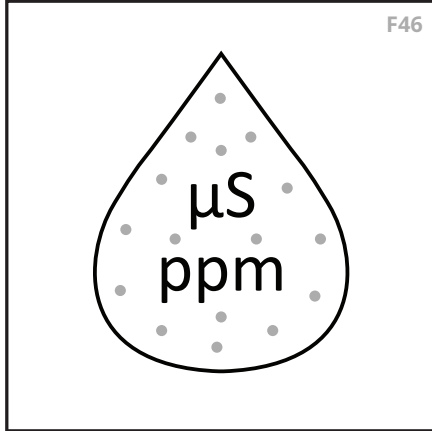

### F46 a: Conductivity (EC)



The conductivity (Electrical Conductance, EC) in microSiemens/cm of the AA's surface water is: [enter reading here; leave blank if not measured]

More Details: See F45 More Details for measurement guidance.

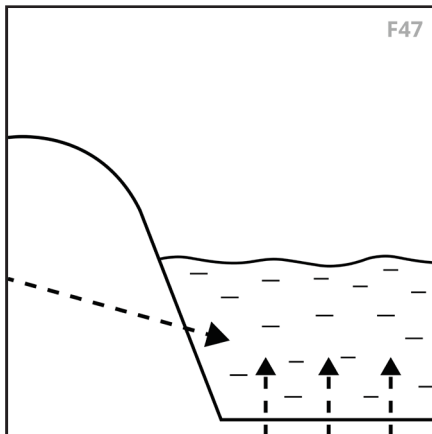

### F47 [AA & Topo]: Groundwater Input Probability



Select the first applicable choice:

More Details: During winter, rust deposits associated with groundwater seen along streams may be most noticeable as orange discoloration in ice formations. The indicator plant species were suggested by Racine & Walters (1991).

**A** Springs are known to be present within the AA; OR most of the AA was excavated below the usual water table level; OR iron floc is extensive or thermal and chemical properties of water strongly suggest substantial groundwater input.

**B** Most of the AA has a slope of >5%, or is very close to the base of a natural slope longer than the maximum dimension of the AA and much steeper than the slope of the AA, OR, if measured, surface water has pH >6.5 and conductivity of >300 μS/cm or TDS of >200 mg/L (ppm). Moss cover, if any, not dominated by Sphagnum. And not a hot spring. Common plants may include ones associated with fen wetlands, e.g., *Menyanthes*, *Potentilla palustris*, *Equisetum fluviatile*.

**C** Neither of above is true, although groundwater may discharge to or flow through the AA. Or groundwater influx is unknown.

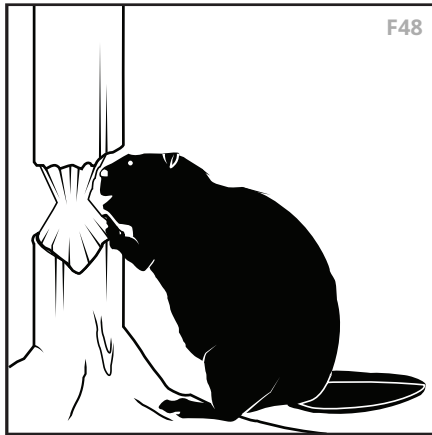

### F48 [AA & Aerial]: Beaver Probability



Use of the AA by beaver during the past 5 years is (select most applicable ONE):

- Evident** from direct observation or presence of gnawed limbs, dams, tracks, dens, lodges, or extensive stands of water-killed trees (snags).
- Likely** based on proximity to suitable habitat, which may include: (a) a persistent freshwater wetland, pond, or lake, or a perennial low or mid-gradient (<6%) channel, and (b) a corridor or multiple stands of hardwood trees and shrubs (>10 cm diameter) near surface water.
- Unlikely** because site characteristics above are deficient, and/or this is a settled area or other area where beaver are routinely removed.

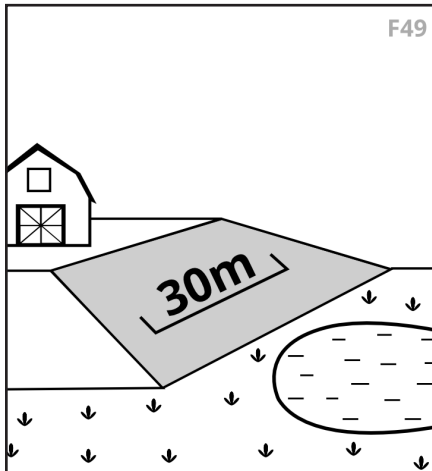

### F49 [U & Aerial]: Disturbance in Wetland Buffer



Within a 30 m-wide buffer around the AA (or a 50 m-wide buffer if the AA is >5 hectares), are there roads, trails, buildings, or any other human-associated features, or areas burned intensively during the past 5 years, that have reduced vegetation normally present on any side of this AA? If no, SKIP TO F53.

- A** Yes
- B** No

**More Details:** The AA buffer is measured perpendicular to the AA perimeter, which is where the AA transitions to upland or to an abutting AA. Reduction includes vegetation removal or damage from trampling, vehicle use, agriculture, mining, construction, etc. If any building is present in the buffer, answer "yes".

**Critical Variable:** This attribute is a primary driver for several ecological models. Prioritize thorough site investigation and verified local knowledge; answering this question accurately is essential for reliable scoring.

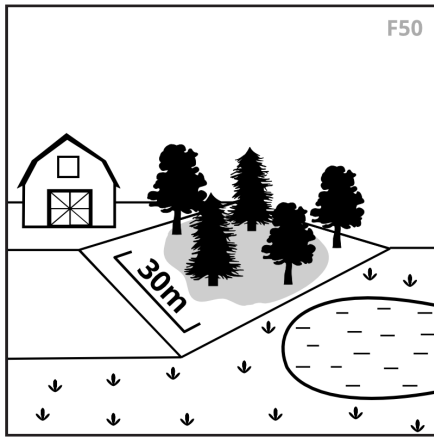

F50

### F50 [U & Aerial]: Vegetated 30m Buffer as % of Perimeter



Within a zone extending 30 m laterally (or 50 m if the AA > 5 ha) from the wetland's edge with upland and/or other wetlands, the percentage that is free of direct human disturbance (i.e., no lawns, row crops, heavily grazed land, plantations of conifers < 2m tall, pavement, buildings) is:

- |               |                  |                   |
|---------------|------------------|-------------------|
| <b>A</b> < 5% | <b>B</b> 5 - 30% | <b>C</b> 31 - 70% |
|---------------|------------------|-------------------|

- |                   |  |
|-------------------|--|
| <b>D</b> 71 - 90% | <b>E</b> >90%, or all of the area within 30 m (or 50 m - if AA > 5 ha) of the AA edge is other wetlands. |
|-------------------|--|

**Critical Variable:** This attribute is a primary driver for several ecological models. Prioritize thorough site investigation and verified local knowledge; answering this question accurately is essential for reliable scoring.

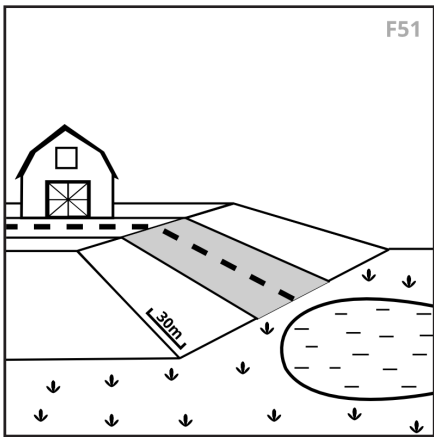

F51

### F51 [U]: Type of Cover in Buffer

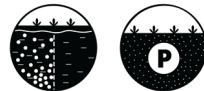

Within 30 m (or 50 m - if AA > 5 ha) upslope of where the wetland transitions to upland, the upland land cover that is NOT perennial vegetation is mostly (mark ONE):

- |   |  |   |
|---|--|---|
| <b>A</b> Impervious surface, e.g., paved road, parking lot, building, exposed rock. | <b>B</b> Bare or nearly bare pervious surface (e.g., unpaved road, dike, burned area, landslide), annual vegetation, row crops, or lawn. | <b>C</b> Neither. All areas within 30 m (or 50 m - if AA > 5 ha) of the wetland edge lack impervious and bare pervious surfaces.<br><b>SKIP to F53.</b> |
|---|--|---|

F52

### F52 [U & Topo]: Buffer Slope



The average percent slope of the upland between the most disturbed part of the 30 m (or 50 m - if AA >5 ha) buffer (the part lacking perennial native vegetation) and the edge of the AA that it potentially drains into is:

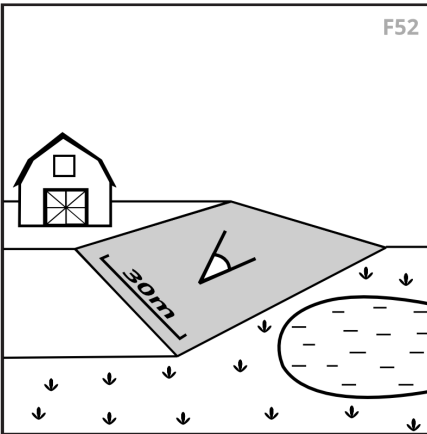

**A** <1% (flat -- almost no noticeable slope), all of the area within 30 m of the AA edge is other wetlands, or none of the disturbed buffer drains into the AA.

**B** < 1 - 5%

**C** 6 - 30%

**D** >30 %

#### F52 Visual Aid |

$$\% \text{ slope} = \frac{\text{rise (vertical distance)}}{\text{run (horizontal distance)}} \times 100\%$$

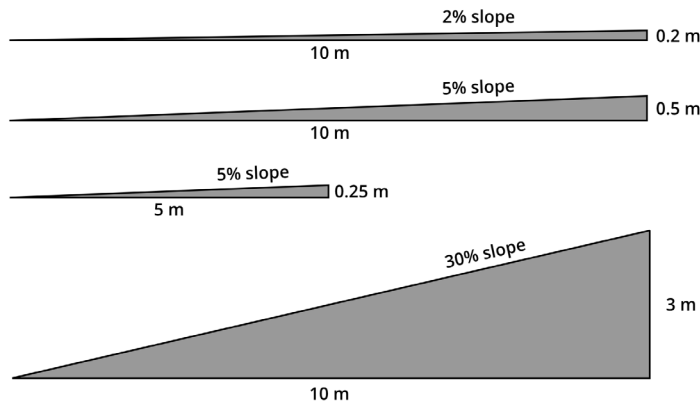

### F53 [U & Aerial]: Distance to Steep Bank, Bridge, Building



The distance from the wetland edge to the closest mostly-bare vertical bank or cliff suitable for bank- or cliff-nesting birds, or to a nest box or platform or other constructed feature (e.g., bridge, building) suitable as nest site for pollinator colonies or nesting swallows, is:

**More Details:** Consult aerial imagery before making final determination.

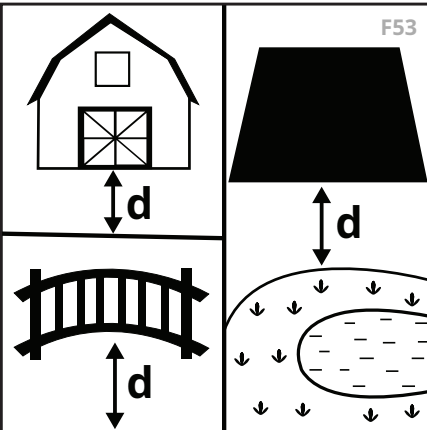

**A** <10 m.

**B** 10 - 30 m.

**C** 31 - 100 m.

**D** 101 - 200 m.

**E** 201 - 500 m.

**F** > 500 m.

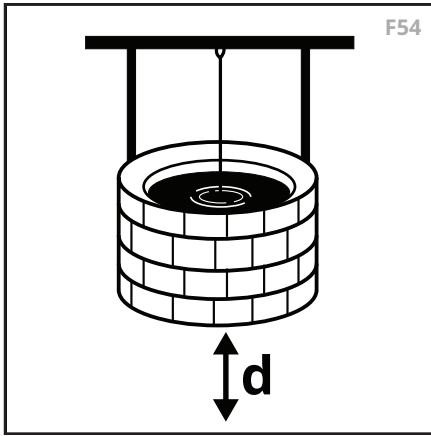

### F54 [U & Aerial]: Domestic Well Proximity



The closest wells or water bodies that currently provide drinking water are:

**More Details:** "Alluvial floodplain landscape" is a largely flat landform created by the deposition of mostly coarse sediment over a long period of time by one or more rivers or glaciers, and/or areas where water levels in the domestic wells are known to closely mimic surface water levels in a

- |  |  |  |
|--|--|--|
| <p><b>A</b> Within 0 - 30 m of the AA.</p>   | <p><b>B</b> 30 - 150 m away and both the wells and the AA are in an alluvial floodplain landscape.</p> | <p><b>C</b> 30 - 150 m away and not in an alluvial floodplain landscape.</p> |
| <p><b>D</b> 150 - 1500 m away and both the wells and the AA are in an alluvial floodplain landscape.</p> | <p><b>E</b> 150 - 1500 m away and not in an alluvial floodplain landscape.</p>                         | <p><b>F</b> &gt; 1500 m away, or no information.</p>                         |

**Critical Variable:** This attribute is a primary driver for several ecological models. Prioritize thorough site investigation and verified local knowledge; answering this question accurately is essential for reliable scoring.

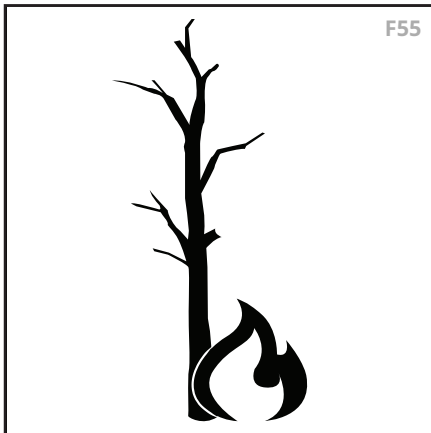

### F55 [AAv & Aerial]: Fire History



More than 1% of the AA's previously vegetated area (select the first true condition):

**More Details:** Look for charred soil or stumps (in multiple widely-spaced locations) or ask landowner. Consult aerial imagery before making final determination.

- |  |   |
|--|---|
| <p><b>A</b> Burned within past 5 years, and &gt;50% of wetland-upland perimeter or area apparently burned, and burned intensely.</p> |   |
| <p><b>B</b> Burned within past 5 years, and &gt;50% of wetland-upland perimeter or area apparently burned, and burned lightly.</p>   |   |
| <p><b>C</b> Burned within past 5 years, and &lt;50% of wetland-upland perimeter apparently burned, and burned intensely.</p>         |   |
| <p><b>D</b> Burned within past 5 years, and &lt;50% of wetland-upland perimeter apparently burned, and burned lightly.</p>           |   |
| <p><b>E</b> Burned 6-10 years ago.</p>   | <p><b>F</b> Burned 11-30 years ago.</p> |
| <p><b>G</b> Burned &gt;30 years ago, or no evidence of a burn and no data.</p>   |   |

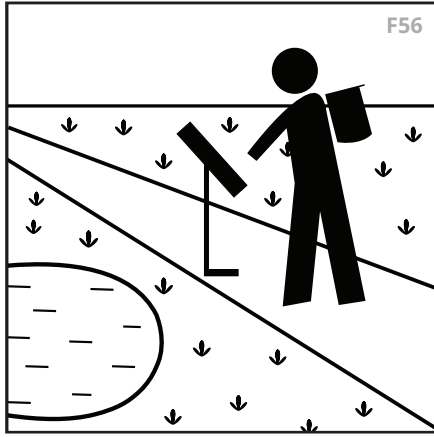

F56

### F56 [AA]: Non-Consumptive Uses - Actual or Potential



Assuming access permission was granted, select ALL statements that are true of the AA as it currently exists:

**A**

For an average person, walking is physically possible in (not just near) >5% of the AA during most of the growing season, e.g., free of deep water and dense shrub thickets.

**B**

Maintained roads, parking areas, or summertime hiking trails are within 10 m of the AA, or the AA can be accessed part of the year by boats arriving via contiguous waters.

**C**

Within the AA or within 100 m of its edge, there is an interpretive center, trails with nature-focused interpretive signs or brochures, and/or regular guided nature tours.

**More Details:** Also consult aerial imagery before making final determination.

**Critical Variable:** This attribute is a primary driver for several ecological models. Prioritize thorough site investigation and verified local knowledge; answering this question accurately is essential for reliable scoring.

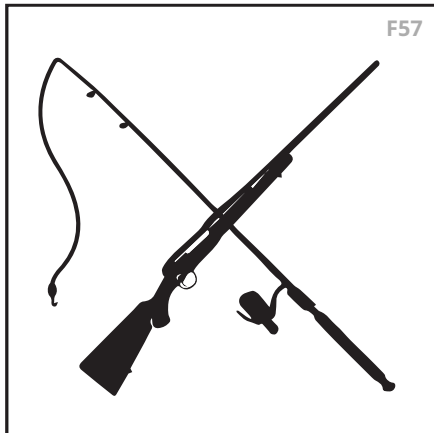

F57

### F57 [AA]: Consumptive Uses (Provisioning Services)



Recent evidence was found within the AA of the following potentially sustainable consumptive uses. Select ALL that apply.

**A**

Low-impact timber harvest (e.g., minor firewood collecting, selective thinning)

**B**

Moose hunting

**C**

Fishing

**D**

Commercial or traditional-use harvesting of living native plants, their fruits, or mushrooms (logging excluded)

**E**

Waterfowl hunting

**F**

Trapping of furbearers

**F**

None of the above.

**More Details:** Evidence can include direct observation, information from reliable sources, or physical evidence such as fishing lures or line, shell casings, blinds, meat poles, or wildlife cameras.

**Critical Variable:** This attribute is a primary driver for several ecological models. Prioritize thorough site investigation and verified local knowledge; answering this question accurately is essential for reliable scoring.

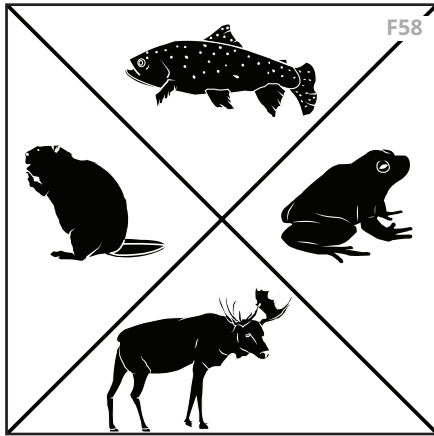

### F58 [AA]: Focal Species Presence



Although WESP-BC does not require undertaking formal surveys for the following wetland-associated species, mark all those observed directly by yourself or other qualified observers you talk with. For animals, indirect evidence noted during the site visit may be considered.

<p><b>A</b> Fish (any species)</p>	<p><b>B</b> Moose</p>	<p><b>C</b> Beaver</p>
<p><b>D</b> One or more small mammals of conservation</p>	<p><b>E</b> Grizzly Bear</p>	<p><b>F</b> Caribou</p>
<p><b>G</b> One or more plant species or plant community of conservation concern (add below)</p>	<p><b>H</b> One or more amphibian species of conservation concern.</p>	
<p><b>I</b> One or more waterbird species of conservation concern.</p>	<p><b>J</b> One or more other wetland bird species of conservation concern.</p>	
<p><b>K</b> One or more reptile species of conservation concern.</p>		

**More Details:** Depending on the species, “indirect evidence” may include tracks, dens, lodges, vocalizations, rubbings, bones, reports from qualified observers, etc. WESP-BC also requires information on rare species occurrences to be entered on Form OF. The lists and records of occurrences may change periodically so check regularly for changes by the BC Conservation Data Centre.

**If any species in the last 4 options were detected, enter those names here:**

---



---



---



---



---



---



# WS?

## F59 [AAv]: Wetland Plant Associations



Enter all wetland plant associations comprising more than 1% of the AA's vegetated area. Enter each plant association name here and the corresponding estimated percent. I.e., if you had a Ws02 that made up 70%, and Wm01 that made up 30%, enter Ws02 70, Wm01 30. If you cannot view the entire AA or do not have the skill to identify and distinguish these from each other, leave this form and the next column blank.

**More Details:** LMH 52 and regional field guides should be considered. Not all site associations will be appropriately defined in these guides, and in these cases identify class and provide description of the dominant plant community.

How many types of wetland plant associations occur in the wetland?:

---

---

---

---

---

---

---

---

---

---

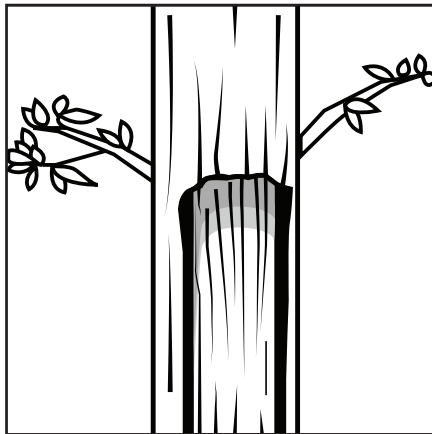

## OPTIONAL [AA + U]: Culturally Significant Features



Mark all those observed directly or from other evidence during the site visit. Do not enter here any information obtained only from other persons or databases.

**More Details:** Due to the diversity of plant uses and the sensitive nature of culturally significant features plants, it is not possible to standardize this question or assign a universal value to cultural use of wetlands. As such, this question is offered to users to note plants culturally significant features of interest, but is not intended to be answered or incorporated into the models of WESP-BC. odically so check regularly for changes by the BC Conservation Data Centre.

**A**

Fish weirs

**B**

Old trails

**C**

Culturally modified trees

**D**

Other evidence of current or ancestral/historic use for spiritual purposes (pit houses, modified depressions)

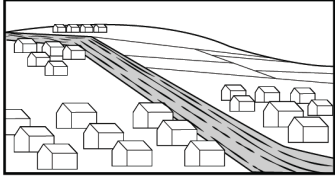
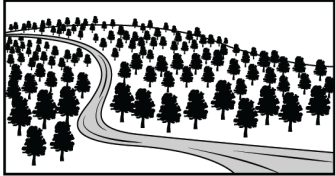

**S1: Altered Timing of Water Inputs**



Mark any item that is likely to have caused the timing of water inputs (but not necessarily their volume) in the AA to shift by hours, days, or weeks, becoming either more flashy (larger or more frequent spikes but over shorter times) or more muted (smaller or less frequent peaks spread over longer times, more temporal homogeneity of flow or water levels).

- |  |  |
|--|--|
| <b>A</b> Runoff that drains directly to the wetland from upslope artificial impervious surfaces.   | <b>B</b> Water subsidies or transfers such as from wastewater effluent, septic system leakage, snow storage areas.   |
| <b>C</b> Regular removal of nearby surface or groundwater for human consumptive uses.  | <b>D</b> Logging or other significant vegetation removal within the wetland or its nearby contributing area.   |
| <b>E</b> Subsidence or compaction as a result of off-road vehicles, machinery, fire, or concentrations of large animals.   | <b>F</b> Flow regulation in tributaries or water level regulation in adjoining or upslope water body, or other control structure at water entry points that regulates inflow to the wetland. |
| <b>G</b> An artificial dam, dike, levee, weir, berm, or fill that interferes with surface or subsurface flow in or out of the AA (e.g., road fills, well pads, pipelines, mining diversion channels, upriver hydroelectric or other dams). | <b>H</b> Artificial drains or ditches in or near the wetland.  |
| <b>I</b> Straightening, ditching, dredging, and/or lining of tributary channels.   | <b>J</b> Accelerated downcutting or channelization of a nearby connected channel (incised below the historical water table level).   |

**S1: Altered Timing of Water Inputs (Continued)**

If you believe the marked items had no measurable effect on the timing of water conditions in any part of the AA, leave this blank. To estimate effects, contrast the current condition with the condition if the checked items never occurred or were no longer present. Example indicators to suggest areas with changes in timing of inputs/outputs: where vegetative cover shifted from wetland to upland species, or where areas of the AA remain flooded year-round where formerly it did not, or all remains dry where formerly it remained flooded year-round.

**Spatial extent within the AA of timing shift.**

- Severe: >95%
- Medium: 5 - 95% of AA
- Mild: <5% of AA
- None

**a**

**If any aberrant timing of inputs or outputs was recorded, mark when most of the timing shift began.**

- Severe: <3 years ago
- Medium: 3-9 years ago
- Mild: 10-100 years ago
- None

**b**

**Mark the degree of flashiness vs. muting.**

Fill in only if the altered inputs began within the last 10 years and only for the part of the wetland that experiences those

- Severe: Became very flashy or controlled
- Medium: Intermediate
- Mild: Became mildly flashy or controlled
- None

**c**

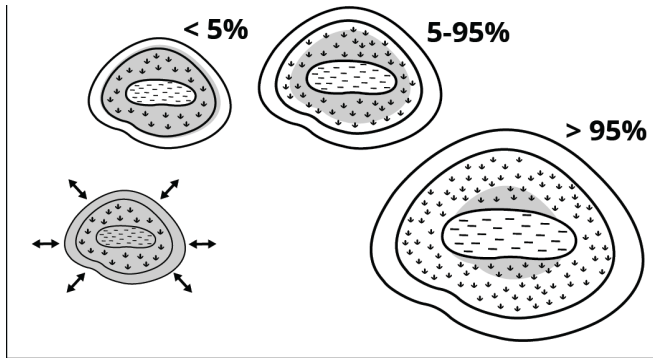

## S2: Accelerated Inputs of Nutrients

Please mark next to any item -- occurring in either the wetland or its CA -- that is likely to have accelerated the inputs of nutrients to the wetland.

**A** Stormwater or wastewater effluent (including failing septic systems), landfills.

**B** Fertilizers applied to lawns, ag lands, or other areas in the CA.

**C** Livestock, dogs, nesting waterbird colonies, ungulate herds.

**D** Artificial drainage of upslope lands by means of ditches feeding into the wetland.

**E** Other waterborne human-related nutrient sources within the CA.

## S2: Accelerated Inputs of Nutrients (Continued)

If you believe the checked items did not cumulatively expose the AA to significantly more nutrients, then leave blank. To estimate effects, contrast the current condition with the condition if the checked items never occurred or were no longer present.

**If any accelerated inputs were marked, please indicate the type of loading.**

- Severe: Large (e.g., feedlots, extensive residential on septic)
- Medium: Moderate (e.g., grazing, light residential on)
- Mild: Limited (e.g., a few animals, lawns, sewered residential)
- None

**a**

**If any accelerated inputs were marked, indicate the frequency & duration of input.**

- Severe: Frequent throughout most of growing season
- Medium: Only during limited parts of the growing season
- Mild: Infrequent & mainly during high runoff events
- None

**b**

**If any accelerated inputs were marked, please indicate AA proximity to main sources (actual or potential).**

If you believe the checked items did not cumulatively expose the AA to significantly more nutrients, then leave blank.

- Severe: 0 - 15 m, or further but on steep erodible slopes
- Medium: 15-100 m. or in groundwater
- Mild: In more distant part of contributing area
- None

**c**

### S3: Accelerated Inputs of Contaminants and/or Salts

Please mark any item -- occurring in either the wetland or its CA -- that is likely to have accelerated the inputs of contaminants or salts to the AA. Estimate the severity of the above marked items using the chart below. If you believe the marked items did not cumulatively expose the AA to significantly higher levels of contaminants and/or salts, then leave this blank. To estimate effects, contrast the current condition with the condition if the checked items never occurred or were no longer present.

<input type="checkbox"/> <b>A</b> Stormwater or wastewater effluent (including failing septic systems), landfills, snow storage	<input type="checkbox"/> <b>B</b> Metals & chemical wastes from mining, shooting ranges, oil/ gas extraction, other sources
<input type="checkbox"/> <b>C</b> Irrigation of lands, especially those with saline soils	<input type="checkbox"/> <b>D</b> Oil or chemical spills (not just chronic inputs) from nearby roads
<input type="checkbox"/> <b>E</b> Fertilizers applied to lawns, ag lands, or other areas in the CA	<input type="checkbox"/> <b>F</b> Pesticides applied to lawns, ag lands, roadsides, or other areas in the CA, but excluding spot applications for controlling non-natives in the AA
<input type="checkbox"/> <b>G</b> Artificial drainage of contaminated or saline soils	<input type="checkbox"/> <b>H</b> Erosion of contaminated soils
<input type="checkbox"/> <b>I</b> Other contaminant sources within the CA	<input type="checkbox"/> <b>J</b> Pesticides as applied for weed control (e.g., along road or powerline rights-of-way, lawns, gardens, croplands) or for mosquito or other pest control

### S3: Accelerated Inputs of Contaminants and/or Salts (Continued)

If you believe the checked items did not cumulatively add significantly more sediment or suspended solids to the AA, leave blank. To estimate effects, contrast the current condition with the condition if the checked items never occurred or were no longer present.

**If any accelerated inputs were marked, indicate the usual toxicity of most toxic contaminants.**

- Severe: Industrial effluent, mining waste, unmanaged landfill
- Medium: Domestic effluent, annual crops, fossil fuel extraction or pipeline, power station
- Mild: Low density residential or commercial
- None

**a**

**If any accelerated inputs were marked, indicate the frequency & duration of input.**

- Severe: Frequent throughout most of growing season
- Medium: Only during limited parts of the growing season
- Mild: Infrequent & mainly during high runoff events
- None

**b**

**If any accelerated inputs were marked, please indicate AA proximity to main sources (actual or potential).**

- Severe: 0 - 15 m, or further but on steep erodible slopes
- Medium: 15-100 m. or in groundwater
- Mild: In more distant part of contributing area
- None

**c**

### S4: Excessive Sediment Loading from Runoff Contributing Area

Please mark next to any item present in the CA that is likely to have elevated the load of waterborne or windborne sediment reaching the wetland from its CA.

If you believe the marked items did not cumulatively add significantly more sediment or suspended solids to the AA, leave this blank.

- |  |  |
|--|--|
| <input type="checkbox"/> <b>A</b> Erosion from plowed fields, fill, timber harvest, dirt roads, vegetation clearing, firesareas, industrial facilities | <input type="checkbox"/> <b>B</b> Erosion from construction, in-channel machinery in the CA      |
| <input type="checkbox"/> <b>C</b> Erosion from off-road vehicles in the CA   | <input type="checkbox"/> <b>D</b> Erosion from livestock or foot traffic in the CA               |
| <input type="checkbox"/> <b>E</b> Stormwater or wastewater effluent  | <input type="checkbox"/> <b>F</b> Sediment from gravel mining, other mining, oil/ gas extraction |
| <input type="checkbox"/> <b>G</b> Accelerated channel downcutting or headcutting of tributaries due to altered land use                                | <input type="checkbox"/> <b>H</b> Other human-related disturbances within the CA                 |

### S4: Excessive Sediment Loading from Runoff Contributing Area (Continued)

If you believe the checked items did not cumulatively add significantly more sediment or suspended solids to the AA, leave next section blank. To estimate effects, contrast the current condition with the condition if the checked items never occurred or were no longer present.

**If any excessive sediment loading was marked, please indicate evidence type.**

- Extensive evidence, high intensity (plowing, grading, excavation, erosion with or without veg removal)
- Potentially (based on high-intensity land user scattered evience [high intensity = plowing, grading, excavation, erosion with or without veg removal])
- Potentially (based on low-intensity land use) with little or no direct evidence. [low-in-tensity = veg removal only with little or no apparent erosion or disturbances of soil or

**a**

**If any excessive sediment loading was marked, please indicate recentness of significant soil disturbance in the CA.**

- Severe: Current & ongoing
- Medium: 1-12 months ago.
- Mild: >1 yr ago
- None

**b**

**If any excessive sediment loading was marked, please indicate duration of sediment inputs to the wetland.**

- Severe: Frequent throughout most of growing season
- Medium: Only during limited parts of the growing season
- Mild: Infrequent & mainly during high runoff events
- None

**c**

**If any excessive sediment loading was marked, please indicate AA proximity to actual or potential sources.**

- Severe: 0 - 15 m, or further but on steep erodible slopes
- Medium: 15-100 m. or in groundwater
- Mild: In more distant part of contributing area
- None

**d**

## S5: Soil or Sediment Alteration Within the Assessment Area

Please mark any item present in the wetland that is likely to have compacted, eroded, or otherwise altered the wetland's soil. Consider only items occurring within past 100 years or since wetland was created or restored (whichever is less).

- |   |  |
|---|--|
| <input type="checkbox"/> <b>A</b> Compaction from livestock, machinery, off-road vehicles, or mountain bikes, etc. especially during wetter periods industrial facilities | <input type="checkbox"/> <b>B</b> Leveling or other grading not to the natural contour   |
| <input type="checkbox"/> <b>C</b> Tillage, plowing (but excluding disking for enhancement of native plants)   | <input type="checkbox"/> <b>D</b> Fill, riprap, or other armoring, excluding small amounts of upland soils containing organic amendments (compost, etc.) or small amounts of topsoil stockpiled or imported from another wetland |
| <input type="checkbox"/> <b>E</b> Excavation  | <input type="checkbox"/> <b>F</b> Ditch cleaning or dredging in or adjacent to the AA  |
| <input type="checkbox"/> <b>G</b> Boat traffic in or adjacent to the AA and sufficient to cause shore erosion or stir bottom sediments                                    | <input type="checkbox"/> <b>H</b> Artificial water level or flow manipulations sufficient to cause erosion or stir bottom sediments  |

## S5: Soil or Sediment Alteration Within the Assessment Area (Continued)

If you believe the checked items did not measurably alter the soil structure and/or topography, then leave blank.

**If any soil or sediment alteration was marked, please indicate the spatial extent of altered soil.**

- Severe: >95% of wetland or >95% of its upland edge (if any)
- Medium: 5-95% of wetland or 5-95% of its upland edge (if any)
- Mild: <5% of wetland and <5% of its upland edge (if any)
- None

**a**

**If any soil or sediment alteration was marked, please indicate recentness of significant soil alteration in wetland.**

- Severe: Current & ongoing
- Medium: 1-12 months ago.
- Mild: >1 yr ago
- None

**b**

**If any soil or sediment alteration was marked, please indicate duration.**

- Severe: Long-lasting, minimal veg recovery
- Medium: Long-lasting but mostly revegetated
- Mild: Short-term, revegetated, not intense
- None

**c**

**If any soil or sediment alteration was marked, please indicate timing of soil alteration.**

- Severe: Frequent throughout most of growing season
- Medium: Only during limited parts of the growing season
- Mild: Infrequent & mainly during high runoff events
- None

**d**

## S6: Wildlife Disturbance Potential

Please mark any item present in the wetland that is likely to have increased the potential for disturbance of wildlife.

- A** Noise exceeding 100 decibels (e.g., the sound of a gas-powered lawnmower, snowmobile, motorboat, or motorcycle at about 3 m, low-elevation aircraft, chainsaw at 15.24 m) when heard from within the wetland.
- B** Powerlines, walls, or fences taller than 1.2 m and longer than 152.4 m that raptors, waterfowl, other birds, and ungulates may collide with.
- C** Stationary floodlights constantly illuminating more than 0.04 hectares of the wetland at night.
- D** Humans visiting the wetland or adjoining areas visible from the wetland.

## S6: Wildlife Disturbance Potential (Continued)

If any items were marked above, please indicate the frequency of the disturbance.

- Severe: Multiple days per week during sensitive time for some species
- Medium: Intermediate
- Mild: Once or twice annually during sensitive time for some
- None

**a**

If any items were marked above, please indicate the duration of the disturbance.

- Severe: Nearly continuous for hours
- Medium: Intermediate
- Mild: Usually less than a few minutes
- None

**b**

On the Survey123, there is the option to provide the following:

- Observed Landcover Types
- Observed Disturbance Types
- Other Notable Features
- Additional comments to help the assessor document the site

# WESP Form Answers:

Wetland ID: \_\_\_\_\_

- F1  A  B  C  D  E  F  G
- Coniferous taller than 3 metres
- F1  A  B  C  D  E  F  G
- Deciduous taller than 3 metres
- F1  A  B  C  D  E  F  G
- Coniferous or Evergreen 1-3 metres tall
- F1  A  B  C  D  E  F  G
- Deciduous 1-3 metres tall
- F1  A  B  C  D  E  F  G
- Coniferous or Evergreen < 1 metres tall
- F1  A  B  C  D  E  F  G
- Deciduous < 1 metres tall
- F1  A  B  C  D  E  F  G
- F2  A1  A2  B1  B2
- Coniferous
- F3  A  B  C  D
- Broad-Leaved Deciduous
- F3  A  B  C  D
- F4  A  B  C  D
- F5  A  B  C  D  E
- F6  A  B  C  D  E
- F7  A  B  C  D  E
- F8  A  B  C
- F9  A  B  C  D
- F10  A  B  C  D  E
- F11  A  B  C  D  E
- F12  A  B  C  D
- F13  A  B  C  D  E
- F14  A  B  C  D  E
- F15  A  B  C  D  E
- F16  A  B  C  D  E
- F17  A  B  C  D  E  F
- F18  A  B  C
- F19  A  B  C  D  E  F
- F20  A  B  C  D  E
- F21  A  B  C  D  E  F

- F22  A  B
- F23  A  B
- F24  A  B  C  D  E
- F25  A  B  C  D  E
- F26  A  B  C  D  E
- F27  A  B  C  D  E  F
- F28  A  B  C
- F29  A  B  C  D  E  F
- F30  A  B  C  D  E  F
- F31  A  B  C  D  E  F
- F32  A  B  C  D  E  F
- F33  A  B  C  D  E  F
- F34  A  B  C  D  E  F
- F35  A  B  C  D
- F36  A  B  C  D  E
- F37  A  B  C  D  E  F
- F38  A  B  C
- F39  A  B  C  D
- F40  A  B  C  D  E
- F41  A  B  C  D
- F42  A  B
- F43  A  B  C  D  E
- F44  A  B  C  D
- F45  A  B  C
- F46
- F47  A  B  C
- F48  A  B  C
- F49  A  B
- F50  A  B  C  D  E
- F51  A  B  C
- F52  A  B  C  D
- F53  A  B  C  D  E  F

- F54  A  B  C  D  E  F
- F55  A  B  C  D  E  F  G
- F56  A  B  C
- F57  A  B  C  D  E  F  G
- F58  A  B  C  D  E  F  G
- H  I  J  K
- F59
- F61
- F60  A  B  C  D

- S1  A  B  C  D  E  F  G
- H  I  J

<input type="checkbox"/> 1	<input type="checkbox"/> 2	<input type="checkbox"/> 1	<input type="checkbox"/> 2	<input type="checkbox"/> 1	<input type="checkbox"/> 2
<input type="checkbox"/> 3	<input type="checkbox"/> 4	<input type="checkbox"/> 3	<input type="checkbox"/> 4	<input type="checkbox"/> 3	<input type="checkbox"/> 4

- S2  A  B  C  D  E

<input type="checkbox"/> 1	<input type="checkbox"/> 2	<input type="checkbox"/> 1	<input type="checkbox"/> 2	<input type="checkbox"/> 1	<input type="checkbox"/> 2
<input type="checkbox"/> 3	<input type="checkbox"/> 4	<input type="checkbox"/> 3	<input type="checkbox"/> 4	<input type="checkbox"/> 3	<input type="checkbox"/> 4

- S3  A  B  C  D  E  F  G
- H  I  J

<input type="checkbox"/> 1	<input type="checkbox"/> 2	<input type="checkbox"/> 1	<input type="checkbox"/> 2	<input type="checkbox"/> 1	<input type="checkbox"/> 2
<input type="checkbox"/> 3	<input type="checkbox"/> 4	<input type="checkbox"/> 3	<input type="checkbox"/> 4	<input type="checkbox"/> 3	<input type="checkbox"/> 4

- S4  A  B  C  D  E  F  G
- H

<input type="checkbox"/> 1	<input type="checkbox"/> 2	<input type="checkbox"/> 1	<input type="checkbox"/> 2	<input type="checkbox"/> 1	<input type="checkbox"/> 2	<input type="checkbox"/> 1	<input type="checkbox"/> 2
<input type="checkbox"/> 3	<input type="checkbox"/> 4	<input type="checkbox"/> 3	<input type="checkbox"/> 4	<input type="checkbox"/> 3	<input type="checkbox"/> 4	<input type="checkbox"/> 3	<input type="checkbox"/> 4

- S5  A  B  C  D  E  F  G
- H

<input type="checkbox"/> 1	<input type="checkbox"/> 2	<input type="checkbox"/> 1	<input type="checkbox"/> 2	<input type="checkbox"/> 1	<input type="checkbox"/> 2	<input type="checkbox"/> 1	<input type="checkbox"/> 2
<input type="checkbox"/> 3	<input type="checkbox"/> 4	<input type="checkbox"/> 3	<input type="checkbox"/> 4	<input type="checkbox"/> 3	<input type="checkbox"/> 4	<input type="checkbox"/> 3	<input type="checkbox"/> 4

- S6  A  B
- C  D
- 1  2
- 3  4
- 1  2
- 3  4

# WESP-BC Assessment Cover Page:

Surveyor(s):

Contact Information:

---

---

---

---

Report date (yy/mm/dd): \_\_\_\_\_

Wetland ID (e.g. SI\_WS26W01): \_\_\_\_\_

Project name/site name: \_\_\_\_\_

Nearest settlement/city: \_\_\_\_\_

EcoProvince: \_\_\_\_\_

BGC zone/subzone: \_\_\_\_\_

Latitude (decimal degrees) (N):

Longitude (decimal degrees) (W):

If delineated, WSA file number (if known):

What percentage (approx.) of the wetland were you able to visit?

---

---

---

---

Version of **wespr** R package used: \_\_\_\_\_

Version of field **Survey123** form used (if known): \_\_\_\_\_

If the wetland has been previously mapped, what is the source of the mapping (e.g., FWA, CRIA, TEM, SEI, CNWI, etc.)?

If the wetland has been previously mapped, what is the unique identifier associated with that wetland?

---

---

---

---

## Predominant Hydrogeomorphic (HGM) Class<sup>1</sup>:

Lacustrine = L; Fluvial = F; Palustrine = P; Basin and Hollows (Pb); Ponds and Potholes (Pp); Seepage Slopes (Ps)

## Canadian Wetland Classification System (CWCS) Class:

Bog = B; Fen = F; Swamp = S (indicate if treed = t or shrubby = s)<sup>2</sup>; Marsh = M; Shallow open water = W

Indicate all present, based on field visit and/or aerial imagery and relative proportion by percent

---

---

---

---

Approximate size of the Assessment Area (AA) in hectares:

AA as a percent of the entire wetland (approx.):

---

---

---

---

Comments about the site or this WESP-BC assessment:

Attach an extra page if desired.

---

---

---

---

Have you attended a WESP-BC training session?

If so, indicate approximate month & year

---

---

How many wetlands have you assessed previously using WESP-BC (approximate)?

---

---

**Include a sketch map of wetland assessment area:**  
Attach an extra page if desired.

<sup>1</sup>For more information refer to Wetlands of British Columbia: A Guide to Identification (LMH52), page 41

<sup>2</sup>In this context treed = >25% of the surface area covered by trees? Trees are woody vegetation >5 meters in height and shrubby = >25% of the surface area covered by shrubs? Shrubs are woody vegetation <5 meters in height and exclusive of dwarf vegetation (e.g., *Vaccinium microcarpum*)

AA = Assessment Area; CWCS = Canadian Wetland Classification System; FWA = Fresh Water Atlas; ID = identification; VRI – Vegetation Resource Inventory; WESP-BC = Wetland Ecosystem Services Protocol for British Columbia; WSA – Water Sustainability Act

# WESP Form Answers:

Wetland ID: \_\_\_\_\_

- F1  A  B  C  D  E  F  G  
Coniferous taller than 3 metres
- F1  A  B  C  D  E  F  G  
Deciduous taller than 3 metres
- F1  A  B  C  D  E  F  G  
Coniferous or Evergreen 1-3 metres tall
- F1  A  B  C  D  E  F  G  
Deciduous 1-3 metres tall
- F1  A  B  C  D  E  F  G  
Coniferous or Evergreen < 1 metres tall
- F1  A  B  C  D  E  F  G  
Deciduous < 1 metres tall
- F2  A1  A2  B1  B2
- F3  A  B  C  D  
Coniferous
- F3  A  B  C  D  
Broad-Leaved Deciduous
- F4  A  B  C  D
- F5  A  B  C  D  E
- F6  A  B  C  D  E
- F7  A  B  C  D  E
- F8  A  B  C
- F9  A  B  C  D
- F10  A  B  C  D  E
- F11  A  B  C  D  E
- F12  A  B  C  D
- F13  A  B  C  D  E
- F14  A  B  C  D  E
- F15  A  B  C  D  E
- F16  A  B  C  D  E
- F17  A  B  C  D  E  F
- F18  A  B  C
- F19  A  B  C  D  E  F
- F20  A  B  C  D  E
- F21  A  B  C  D  E  F

- F22  A  B
- F23  A  B
- F24  A  B  C  D  E
- F25  A  B  C  D  E
- F26  A  B  C  D  E
- F27  A  B  C  D  E  F
- F28  A  B  C
- F29  A  B  C  D  E  F
- F30  A  B  C  D  E  F
- F31  A  B  C  D  E  F
- F32  A  B  C  D  E  F
- F33  A  B  C  D  E  F
- F34  A  B  C  D  E  F
- F35  A  B  C  D
- F36  A  B  C  D  E
- F37  A  B  C  D  E  F
- F38  A  B  C
- F39  A  B  C  D
- F40  A  B  C  D  E
- F41  A  B  C  D
- F42  A  B
- F43  A  B  C  D  E
- F44  A  B  C  D
- F45  A  B  C
- F46
- F47  A  B  C
- F48  A  B  C
- F49  A  B
- F50  A  B  C  D  E
- F51  A  B  C
- F52  A  B  C  D
- F53  A  B  C  D  E  F

- F54  A  B  C  D  E  F
- F55  A  B  C  D  E  F  G
- F56  A  B  C
- F57  A  B  C  D  E  F  G
- F58  A  B  C  D  E  F  G  
 H  I  J  K
- F59
- F61
- F60  A  B  C  D

- S1  A  B  C  D  E  F  G  
 H  I  J

<input type="radio"/> 1 <input type="radio"/> 3	<input type="radio"/> 2 <input type="radio"/> 4	<input type="radio"/> 1 <input type="radio"/> 3	<input type="radio"/> 2 <input type="radio"/> 4	<input type="radio"/> 1 <input type="radio"/> 3	<input type="radio"/> 2 <input type="radio"/> 4
a		b		c	

- S2  A  B  C  D  E

<input type="radio"/> 1 <input type="radio"/> 3	<input type="radio"/> 2 <input type="radio"/> 4	<input type="radio"/> 1 <input type="radio"/> 3	<input type="radio"/> 2 <input type="radio"/> 4	<input type="radio"/> 1 <input type="radio"/> 3	<input type="radio"/> 2 <input type="radio"/> 4
a		b		c	

- S3  A  B  C  D  E  F  G  
 H  I  J

<input type="radio"/> 1 <input type="radio"/> 3	<input type="radio"/> 2 <input type="radio"/> 4	<input type="radio"/> 1 <input type="radio"/> 3	<input type="radio"/> 2 <input type="radio"/> 4	<input type="radio"/> 1 <input type="radio"/> 3	<input type="radio"/> 2 <input type="radio"/> 4
a		b		c	

- S4  A  B  C  D  E  F  G  
 H

<input type="radio"/> 1 <input type="radio"/> 3	<input type="radio"/> 2 <input type="radio"/> 4	<input type="radio"/> 1 <input type="radio"/> 3	<input type="radio"/> 2 <input type="radio"/> 4	<input type="radio"/> 1 <input type="radio"/> 3	<input type="radio"/> 2 <input type="radio"/> 4	<input type="radio"/> 1 <input type="radio"/> 3	<input type="radio"/> 2 <input type="radio"/> 4
a		b		c		d	

- S5  A  B  C  D  E  F  G  
 H

<input type="radio"/> 1 <input type="radio"/> 3	<input type="radio"/> 2 <input type="radio"/> 4	<input type="radio"/> 1 <input type="radio"/> 3	<input type="radio"/> 2 <input type="radio"/> 4	<input type="radio"/> 1 <input type="radio"/> 3	<input type="radio"/> 2 <input type="radio"/> 4	<input type="radio"/> 1 <input type="radio"/> 3	<input type="radio"/> 2 <input type="radio"/> 4
a		b		c		d	

- S6  A  B  
 C  D  

<input type="radio"/> 1 <input type="radio"/> 3	<input type="radio"/> 2 <input type="radio"/> 4	<input type="radio"/> 1 <input type="radio"/> 3	<input type="radio"/> 2 <input type="radio"/> 4
a		b	

# WESP-BC Assessment Cover Page:

Surveyor(s):

Contact Information:

---

---

---

---

Report date (yy/mm/dd): \_\_\_\_\_

Wetland ID (e.g. SI\_WS26W01): \_\_\_\_\_

Project name/site name: \_\_\_\_\_

Nearest settlement/city: \_\_\_\_\_

EcoProvince: \_\_\_\_\_

BGC zone/subzone: \_\_\_\_\_

Latitude (decimal degrees) (N):

Longitude (decimal degrees) (W):

If delineated, WSA file number (if known):

What percentage (approx.) of the wetland were you able to visit?

---

---

---

---

Version of **wespr** R package used: \_\_\_\_\_

Version of field **Survey123** form used (if known): \_\_\_\_\_

If the wetland has been previously mapped, what is the source of the mapping (e.g., FWA, CRIA, TEM, SEI, CNWI, etc.)?

If the wetland has been previously mapped, what is the unique identifier associated with that wetland?

---

---

---

---

## Predominant Hydrogeomorphic (HGM) Class<sup>1</sup>:

Lacustrine = L; Fluvial = F; Palustrine = P; Basin and Hollows (Pb); Ponds and Potholes (Pp); Seepage Slopes (Ps)

## Canadian Wetland Classification System (CWCS) Class:

Bog = B; Fen = F; Swamp = S (indicate if treed = t or shrubby = s)<sup>2</sup>; Marsh = M; Shallow open water = W

Indicate all present, based on field visit and/or aerial imagery and relative proportion by percent

---

---

---

---

Approximate size of the Assessment Area (AA) in hectares:

AA as a percent of the entire wetland (approx.):

---

---

---

---

Comments about the site or this WESP-BC assessment:

Attach an extra page if desired.

---

---

---

---

Have you attended a WESP-BC training session?

If so, indicate approximate month & year

---

---

How many wetlands have you assessed previously using WESP-BC (approximate)?

---

---

## Include a sketch map of wetland assessment area:

Attach an extra page if desired.

<sup>1</sup>For more information refer to Wetlands of British Columbia: A Guide to Identification (LMH52), page 41

<sup>2</sup>In this context treed = >25% of the surface area covered by trees? Trees are woody vegetation >5 meters in height and shrubby = >25% of the surface area covered by shrubs? Shrubs are woody vegetation <5 meters in height and exclusive of dwarf vegetation (e.g., *Vaccinium microcarpum*)

AA = Assessment Area; CWCS = Canadian Wetland Classification System; FWA = Fresh Water Atlas; ID = identification; VRI – Vegetation Resource Inventory; WESP-BC = Wetland Ecosystem Services Protocol for British Columbia; WSA – Water Sustainability Act

# WESP Form Answers:

Wetland ID: \_\_\_\_\_

Coniferous taller than 3 metres

F1 (A) (B) (C) (D) (E) (F) (G)

Deciduous taller than 3 metres

F1 (A) (B) (C) (D) (E) (F) (G)

Coniferous or Evergreen 1-3 metres tall

F1 (A) (B) (C) (D) (E) (F) (G)

Deciduous 1-3 metres tall

F1 (A) (B) (C) (D) (E) (F) (G)

Coniferous or Evergreen < 1 metres tall

F1 (A) (B) (C) (D) (E) (F) (G)

Deciduous < 1 metres tall

F1 (A) (B) (C) (D) (E) (F) (G)

F2 (A1) (A2) (B1) (B2)

Coniferous

F3 (A) (B) (C) (D)

Broad-Leaved Deciduous

F3 (A) (B) (C) (D)

F4 (A) (B) (C) (D)

F5 (A) (B) (C) (D) (E)

F6 (A) (B) (C) (D) (E)

F7 (A) (B) (C) (D) (E)

F8 (A) (B) (C)

F9 (A) (B) (C) (D)

F10 (A) (B) (C) (D) (E)

F11 (A) (B) (C) (D) (E)

F12 (A) (B) (C) (D)

F13 (A) (B) (C) (D) (E)

F14 (A) (B) (C) (D) (E)

F15 (A) (B) (C) (D) (E)

F16 (A) (B) (C) (D) (E)

F17 (A) (B) (C) (D) (E) (F)

F18 (A) (B) (C)

F19 (A) (B) (C) (D) (E) (F)

F20 (A) (B) (C) (D) (E)

F21 (A) (B) (C) (D) (E) (F)

F22 (A) (B)

F23 (A) (B)

F24 (A) (B) (C) (D) (E)

F25 (A) (B) (C) (D) (E)

F26 (A) (B) (C) (D) (E)

F27 (A) (B) (C) (D) (E) (F)

F28 (A) (B) (C)

F29 (A) (B) (C) (D) (E) (F)

F30 (A) (B) (C) (D) (E) (F)

F31 (A) (B) (C) (D) (E) (F)

F32 (A) (B) (C) (D) (E) (F)

F33 (A) (B) (C) (D) (E) (F)

F34 (A) (B) (C) (D) (E) (F)

F35 (A) (B) (C) (D)

F36 (A) (B) (C) (D) (E)

F37 (A) (B) (C) (D) (E) (F)

F38 (A) (B) (C)

F39 (A) (B) (C) (D)

F40 (A) (B) (C) (D) (E)

F41 (A) (B) (C) (D)

F42 (A) (B)

F43 (A) (B) (C) (D) (E)

F44 (A) (B) (C) (D)

F45 (A) (B) (C)

F46 (A) (B) (C)

F47 (A) (B) (C)

F48 (A) (B) (C)

F49 (A) (B)

F50 (A) (B) (C) (D) (E)

F51 (A) (B) (C)

F52 (A) (B) (C) (D)

F53 (A) (B) (C) (D) (E) (F)

F54 (A) (B) (C) (D) (E) (F)

F55 (A) (B) (C) (D) (E) (F) (G)

F56 (A) (B) (C)

F57 (A) (B) (C) (D) (E) (F) (G)

F58 (A) (B) (C) (D) (E) (F) (G)

(H) (I) (J) (K)

F59

F61

F60 (A) (B) (C) (D)

S1 (A) (B) (C) (D) (E) (F) (G)

(H) (I) (J)

(1) (2) (3) (4) (1) (2) (3) (4) (1) (2) (3) (4)

a b c

S2 (A) (B) (C) (D) (E)

(1) (2) (3) (4) (1) (2) (3) (4) (1) (2) (3) (4)

a b c

S3 (A) (B) (C) (D) (E) (F) (G)

(H) (I) (J)

(1) (2) (3) (4) (1) (2) (3) (4) (1) (2) (3) (4)

a b c

S4 (A) (B) (C) (D) (E) (F) (G)

(H)

(1) (2) (3) (4) (1) (2) (3) (4) (1) (2) (3) (4) (1) (2) (3) (4)

a b c d

S5 (A) (B) (C) (D) (E) (F) (G)

(H)

(1) (2) (3) (4) (1) (2) (3) (4) (1) (2) (3) (4) (1) (2) (3) (4)

a b c d

S6 (A) (B) (C) (D)

(1) (2) (3) (4) (1) (2) (3) (4)

a b

(1) (2) (3) (4) (1) (2) (3) (4)

a b

(1) (2) (3) (4) (1) (2) (3) (4)

a b

(1) (2) (3) (4) (1) (2) (3) (4)

a b

(1) (2) (3) (4) (1) (2) (3) (4)

# WESP-BC Assessment Cover Page:

Surveyor(s):

Contact Information:

\_\_\_\_\_

\_\_\_\_\_

Report date (yy/mm/dd): \_\_\_\_\_

Wetland ID (e.g. SI\_WS26W01): \_\_\_\_\_

Project name/site name: \_\_\_\_\_

Nearest settlement/city: \_\_\_\_\_

EcoProvince: \_\_\_\_\_

BGC zone/subzone: \_\_\_\_\_

Latitude (decimal degrees) (N):

Longitude (decimal degrees) (W):

If delineated, WSA file number (if known):

What percentage (approx.) of the wetland were you able to visit?

\_\_\_\_\_

\_\_\_\_\_

Version of **wespr** R package used: \_\_\_\_\_

Version of field **Survey123** form used (if known): \_\_\_\_\_

If the wetland has been previously mapped, what is the source of the mapping (e.g., FWA, CRIA, TEM, SEI, CNWI, etc.)?

If the wetland has been previously mapped, what is the unique identifier associated with that wetland?

\_\_\_\_\_

\_\_\_\_\_

## Predominant Hydrogeomorphic (HGM) Class<sup>1</sup>:

Lacustrine = L; Fluvial = F; Palustrine = P; Basin and Hollows (Pb); Ponds and Potholes (Pp); Seepage Slopes (Ps)

## Canadian Wetland Classification System (CWCS) Class:

Bog = B; Fen = F; Swamp = S (indicate if treed = t or shrubby = s)<sup>2</sup>; Marsh = M; Shallow open water = W

Indicate all present, based on field visit and/or aerial imagery and relative proportion by percent

Approximate size of the Assessment Area (AA) in hectares:

AA as a percent of the entire wetland (approx.):

\_\_\_\_\_

\_\_\_\_\_

Comments about the site or this WESP-BC assessment:

Attach an extra page if desired.

\_\_\_\_\_

\_\_\_\_\_

Have you attended a WESP-BC training session?

If so, indicate approximate month & year

\_\_\_\_\_

How many wetlands have you assessed previously using WESP-BC (approximate)?

\_\_\_\_\_

## Include a sketch map of wetland assessment area:

Attach an extra page if desired.

<sup>1</sup>For more information refer to Wetlands of British Columbia: A Guide to Identification (LMH52), page 41

<sup>2</sup>In this context treed = >25% of the surface area covered by trees? Trees are woody vegetation >5 meters in height and shrubby = >25% of the surface area covered by shrubs? Shrubs are woody vegetation <5 meters in height and exclusive of dwarf vegetation (e.g., *Vaccinium microcarpum*)

AA = Assessment Area; CWCS = Canadian Wetland Classification System; FWA = Fresh Water Atlas; ID = identification; VRI – Vegetation Resource Inventory; WESP-BC = Wetland Ecosystem Services Protocol for British Columbia; WSA – Water Sustainability Act

# WESP Form Answers:

Wetland ID: \_\_\_\_\_

Coniferous taller than 3 metres

F1 (A) (B) (C) (D) (E) (F) (G)

Deciduous taller than 3 metres

F1 (A) (B) (C) (D) (E) (F) (G)

Coniferous or Evergreen 1-3 metres tall

F1 (A) (B) (C) (D) (E) (F) (G)

Deciduous 1-3 metres tall

F1 (A) (B) (C) (D) (E) (F) (G)

Coniferous or Evergreen < 1 metres tall

F1 (A) (B) (C) (D) (E) (F) (G)

Deciduous < 1 metres tall

F1 (A) (B) (C) (D) (E) (F) (G)

F2 (A1) (A2) (B1) (B2)

Coniferous

F3 (A) (B) (C) (D)

Broad-Leaved Deciduous

F3 (A) (B) (C) (D)

F4 (A) (B) (C) (D)

F5 (A) (B) (C) (D) (E)

F6 (A) (B) (C) (D) (E)

F7 (A) (B) (C) (D) (E)

F8 (A) (B) (C)

F9 (A) (B) (C) (D)

F10 (A) (B) (C) (D) (E)

F11 (A) (B) (C) (D) (E)

F12 (A) (B) (C) (D)

F13 (A) (B) (C) (D) (E)

F14 (A) (B) (C) (D) (E)

F15 (A) (B) (C) (D) (E)

F16 (A) (B) (C) (D) (E)

F17 (A) (B) (C) (D) (E) (F)

F18 (A) (B) (C)

F19 (A) (B) (C) (D) (E) (F)

F20 (A) (B) (C) (D) (E)

F21 (A) (B) (C) (D) (E) (F)

F22 (A) (B)

F23 (A) (B)

F24 (A) (B) (C) (D) (E)

F25 (A) (B) (C) (D) (E)

F26 (A) (B) (C) (D) (E)

F27 (A) (B) (C) (D) (E) (F)

F28 (A) (B) (C)

F29 (A) (B) (C) (D) (E) (F)

F30 (A) (B) (C) (D) (E) (F)

F31 (A) (B) (C) (D) (E) (F)

F32 (A) (B) (C) (D) (E) (F)

F33 (A) (B) (C) (D) (E) (F)

F34 (A) (B) (C) (D) (E) (F)

F35 (A) (B) (C) (D)

F36 (A) (B) (C) (D) (E)

F37 (A) (B) (C) (D) (E) (F)

F38 (A) (B) (C)

F39 (A) (B) (C) (D)

F40 (A) (B) (C) (D) (E)

F41 (A) (B) (C) (D)

F42 (A) (B)

F43 (A) (B) (C) (D) (E)

F44 (A) (B) (C) (D)

F45 (A) (B) (C)

F46 (A) (B) (C)

F47 (A) (B) (C)

F48 (A) (B) (C)

F49 (A) (B)

F50 (A) (B) (C) (D) (E)

F51 (A) (B) (C)

F52 (A) (B) (C) (D)

F53 (A) (B) (C) (D) (E) (F)

F54 (A) (B) (C) (D) (E) (F)

F55 (A) (B) (C) (D) (E) (F) (G)

F56 (A) (B) (C)

F57 (A) (B) (C) (D) (E) (F) (G)

F58 (A) (B) (C) (D) (E) (F) (G)

(H) (I) (J) (K)

F59

F61

F60 (A) (B) (C) (D)

S1 (A) (B) (C) (D) (E) (F) (G)

(H) (I) (J)

1	2	1	2	1	2
3	4	3	4	3	4

S2 (A) (B) (C) (D) (E)

1	2	1	2	1	2
3	4	3	4	3	4

S3 (A) (B) (C) (D) (E) (F) (G)

(H) (I) (J)

1	2	1	2	1	2
3	4	3	4	3	4

S4 (A) (B) (C) (D) (E) (F) (G)

(H)

1	2	1	2	1	2	1	2
3	4	3	4	3	4	3	4

S5 (A) (B) (C) (D) (E) (F) (G)

(H)

1	2	1	2	1	2	1	2
3	4	3	4	3	4	3	4

S6 (A) (B)

(C) (D)

1	2	1	2
3	4	3	4

# WESP-BC Assessment Cover Page:

Surveyor(s):

---

---

Contact Information:

---

---

Report date (yy/mm/dd): \_\_\_\_\_

Wetland ID (e.g. SI\_WS26W01): \_\_\_\_\_

Project name/site name: \_\_\_\_\_

Nearest settlement/city: \_\_\_\_\_

EcoProvince: \_\_\_\_\_

BGC zone/subzone: \_\_\_\_\_

Latitude (decimal degrees) (N):

Longitude (decimal degrees) (W):

If delineated, WSA file number (if known):

What percentage (approx.) of the wetland were you able to visit?

---

---

Version of **wespr** R package used: \_\_\_\_\_

Version of field **Survey123** form used (if known): \_\_\_\_\_

If the wetland has been previously mapped, what is the source of the mapping (e.g., FWA, CRIA, TEM, SEI, CNWI, etc.)?

If the wetland has been previously mapped, what is the unique identifier associated with that wetland?

---

---

## Predominant Hydrogeomorphic (HGM) Class<sup>1</sup>:

Lacustrine = L; Fluvial = F; Palustrine = P; Basin and Hollows (Pb); Ponds and Potholes (Pp); Seepage Slopes (Ps)

## Canadian Wetland Classification System (CWCS) Class:

Bog = B; Fen = F; Swamp = S (indicate if treed = t or shrubby = s)<sup>2</sup>; Marsh = M; Shallow open water = W

Indicate all present, based on field visit and/or aerial imagery and relative proportion by percent

Approximate size of the Assessment Area (AA) in hectares:

AA as a percent of the entire wetland (approx.):

---

**Include a sketch map of wetland assessment area:**  
Attach an extra page if desired.

Comments about the site or this WESP-BC assessment:

Attach an extra page if desired.

---

---

Have you attended a WESP-BC training session?

If so, indicate approximate month & year

---

How many wetlands have you assessed previously using WESP-BC (approximate)?

---

<sup>1</sup>For more information refer to Wetlands of British Columbia: A Guide to Identification (LMH52), page 41

<sup>2</sup>In this context treed = >25% of the surface area covered by trees? Trees are woody vegetation >5 meters in height and shrubby = >25% of the surface area covered by shrubs? Shrubs are woody vegetation <5 meters in height and exclusive of dwarf vegetation (e.g., *Vaccinium microcarpum*)

AA = Assessment Area; CWCS = Canadian Wetland Classification System; FWA = Fresh Water Atlas; ID = identification; VRI – Vegetation Resource Inventory; WESP-BC = Wetland Ecosystem Services Protocol for British Columbia; WSA – Water Sustainability Act

# WESP Form Answers:

Wetland ID: \_\_\_\_\_

- F1  A  B  C  D  E  F  G
- Coniferous taller than 3 metres
- F1  A  B  C  D  E  F  G
- Deciduous taller than 3 metres
- F1  A  B  C  D  E  F  G
- Coniferous or Evergreen 1-3 metres tall
- F1  A  B  C  D  E  F  G
- Deciduous 1-3 metres tall
- F1  A  B  C  D  E  F  G
- Coniferous or Evergreen < 1 metres tall
- F1  A  B  C  D  E  F  G
- Deciduous < 1 metres tall
- F1  A  B  C  D  E  F  G
- F2  A1  A2  B1  B2
- Coniferous
- F3  A  B  C  D
- Broad-Leaved Deciduous
- F3  A  B  C  D
- F4  A  B  C  D
- F5  A  B  C  D  E
- F6  A  B  C  D  E
- F7  A  B  C  D  E
- F8  A  B  C
- F9  A  B  C  D
- F10  A  B  C  D  E
- F11  A  B  C  D  E
- F12  A  B  C  D
- F13  A  B  C  D  E
- F14  A  B  C  D  E
- F15  A  B  C  D  E
- F16  A  B  C  D  E
- F17  A  B  C  D  E  F
- F18  A  B  C
- F19  A  B  C  D  E  F
- F20  A  B  C  D  E
- F21  A  B  C  D  E  F

- F22  A  B
- F23  A  B
- F24  A  B  C  D  E
- F25  A  B  C  D  E
- F26  A  B  C  D  E
- F27  A  B  C  D  E  F
- F28  A  B  C
- F29  A  B  C  D  E  F
- F30  A  B  C  D  E  F
- F31  A  B  C  D  E  F
- F32  A  B  C  D  E  F
- F33  A  B  C  D  E  F
- F34  A  B  C  D  E  F
- F35  A  B  C  D
- F36  A  B  C  D  E
- F37  A  B  C  D  E  F
- F38  A  B  C
- F39  A  B  C  D
- F40  A  B  C  D  E
- F41  A  B  C  D
- F42  A  B
- F43  A  B  C  D  E
- F44  A  B  C  D
- F45  A  B  C
- F46  A  B  C
- F47  A  B  C
- F48  A  B  C
- F49  A  B
- F50  A  B  C  D  E
- F51  A  B  C
- F52  A  B  C  D
- F53  A  B  C  D  E  F

- F54  A  B  C  D  E  F
  - F55  A  B  C  D  E  F  G
  - F56  A  B  C
  - F57  A  B  C  D  E  F  G
  - F58  A  B  C  D  E  F  G  H  I  J  K
  - F59
  - F61
  - F60  A  B  C  D
- 
- S1  A  B  C  D  E  F  G  H  I  J
  - |   |   |
|---|---|
| 1 | 2 |
| 3 | 4 |

 a
  - |   |   |
|---|---|
| 1 | 2 |
| 3 | 4 |

 b
  - |   |   |
|---|---|
| 1 | 2 |
| 3 | 4 |

 c
  - S2  A  B  C  D  E
  - |   |   |
|---|---|
| 1 | 2 |
| 3 | 4 |

 a
  - |   |   |
|---|---|
| 1 | 2 |
| 3 | 4 |

 b
  - |   |   |
|---|---|
| 1 | 2 |
| 3 | 4 |

 c
  - S3  A  B  C  D  E  F  G  H  I  J
  - |   |   |
|---|---|
| 1 | 2 |
| 3 | 4 |

 a
  - |   |   |
|---|---|
| 1 | 2 |
| 3 | 4 |

 b
  - |   |   |
|---|---|
| 1 | 2 |
| 3 | 4 |

 c
  - S4  A  B  C  D  E  F  G  H
  - |   |   |
|---|---|
| 1 | 2 |
| 3 | 4 |

 a
  - |   |   |
|---|---|
| 1 | 2 |
| 3 | 4 |

 b
  - |   |   |
|---|---|
| 1 | 2 |
| 3 | 4 |

 c
  - |   |   |
|---|---|
| 1 | 2 |
| 3 | 4 |

 d
  - S5  A  B  C  D  E  F  G  H
  - |   |   |
|---|---|
| 1 | 2 |
| 3 | 4 |

 a
  - |   |   |
|---|---|
| 1 | 2 |
| 3 | 4 |

 b
  - |   |   |
|---|---|
| 1 | 2 |
| 3 | 4 |

 c
  - |   |   |
|---|---|
| 1 | 2 |
| 3 | 4 |

 d
  - S6  A  B  C  D 

1	2
3	4

 a 

1	2
3	4

 b

# WESP-BC Assessment Cover Page:

Surveyor(s):

---

---

Contact Information:

---

---

Report date (yy/mm/dd): \_\_\_\_\_

Wetland ID (e.g. SI\_WS26W01): \_\_\_\_\_

Project name/site name: \_\_\_\_\_

Nearest settlement/city: \_\_\_\_\_

EcoProvince: \_\_\_\_\_

BGC zone/subzone: \_\_\_\_\_

Latitude (decimal degrees) (N):

Longitude (decimal degrees) (W):

If delineated, WSA file number (if known):

What percentage (approx.) of the wetland were you able to visit?

---

---

Version of **wespr** R package used: \_\_\_\_\_

Version of field **Survey123** form used (if known): \_\_\_\_\_

If the wetland has been previously mapped, what is the source of the mapping (e.g., FWA, CRIA, TEM, SEI, CNWI, etc.)?

If the wetland has been previously mapped, what is the unique identifier associated with that wetland?

---

---

## Predominant Hydrogeomorphic (HGM) Class<sup>1</sup>:

Lacustrine = L; Fluvial = F; Palustrine = P; Basin and Hollows (Pb); Ponds and Potholes (Pp); Seepage Slopes (Ps)

## Canadian Wetland Classification System (CWCS) Class:

Bog = B; Fen = F; Swamp = S (indicate if treed = t or shrubby = s)<sup>2</sup>; Marsh = M; Shallow open water = W

Indicate all present, based on field visit and/or aerial imagery and relative proportion by percent

Approximate size of the Assessment Area (AA) in hectares:

AA as a percent of the entire wetland (approx.):

---

## Include a sketch map of wetland assessment area:

Attach an extra page if desired.

Comments about the site or this WESP-BC assessment:

Attach an extra page if desired.

---

---

Have you attended a WESP-BC training session?

If so, indicate approximate month & year

---

How many wetlands have you assessed previously using WESP-BC (approximate)?

---

<sup>1</sup>For more information refer to Wetlands of British Columbia: A Guide to Identification (LMH52), page 41

<sup>2</sup>In this context treed = >25% of the surface area covered by trees? Trees are woody vegetation >5 meters in height and shrubby = >25% of the surface area covered by shrubs? Shrubs are woody vegetation <5 meters in height and exclusive of dwarf vegetation (e.g., *Vaccinium microcarpum*)

AA = Assessment Area; CWCS = Canadian Wetland Classification System; FWA = Fresh Water Atlas; ID = identification; VRI – Vegetation Resource Inventory; WESP-BC = Wetland Ecosystem Services Protocol for British Columbia; WSA – Water Sustainability Act